



ROCKEX MINING CORPORATION

ROCKEX MINING CORPORATION

Technical Report on the Updated Preliminary Economic Assessment including HBI Process for the Lake St. Joseph Iron Property

4284 | M03802A

October 26th, 2015

M03802A CIMA+

CIMA
Partners in excellence

ROCKEX MINING CORPORATION

Technical Report on the Updated Preliminary Economic Assessment including HBI Process for the Lake St Joseph Iron Property

4284 | M03802A

Qualified Persons:

Michel L. Bilodeau, Eng. Independent consultant

Yves Buro, Eng. Met-Chem

Jeffrey Cassoff, Eng. Met-Chem

Georgi Doundarov, P.Eng. Independent consultant

Schadrac Ibrango, P.Geo., Ph.D. Met-Chem

Jean-Sébastien Tremblay, Eng. CIMA+

CIMA+

740 Notre-Dame street West
Suite 900
Montreal (Quebec) H3C 3X6

October 26th, 2015

CIMA+ M03802A



Table of Contents

1	Summary.....	1
1.1	Executive Summary	1
1.2	Property Description and Ownership.....	3
1.3	Geology and Mineralization	4
1.4	Status of Exploration, Development and Operations	4
1.5	Mineral Processing and Metallurgical Testing.....	4
1.5.1	Comminution Tests.....	5
1.5.2	Gravity Separation Tests	5
1.5.3	Magnetic Separation Tests	6
1.5.4	Desliming Tests	6
1.5.5	Flotation Tests	6
1.6	Mineral Resource Estimate	7
1.7	Mineral Reserve Estimate.....	8
1.8	Mining Methods.....	8
1.9	Recovery Methods	9
1.9.1	Concentrator	9
1.9.2	Pellet Plant.....	10
1.9.3	Hot Briquetted Iron (HBI) Plant	11
1.10	Project Infrastructures.....	12
1.11	Market Studies and Pricing	12
1.12	Environment Studies, Permitting and Social or Community Impact	13
1.13	Capital and Operating Costs.....	13
1.14	Economic Analysis	15
1.15	Recommendations	16
1.15.1	Geology	16
1.15.2	Mining	17
1.15.3	Metallurgy	17
1.15.4	Environment and Social Aspects	19
1.15.5	Infrastructure.....	19
2	Introduction.....	20
2.1	Scope of Study	20
2.2	Sources of Information.....	22



2.3	Site Visit	22
3	Reliance on Other Experts	23
4	Property Description and Location	24
4.1	Property Location	24
4.2	Property Description and Ownership.....	24
4.3	Issuers Interest.....	30
4.4	Legal Survey	30
4.5	Environmental Liabilities.....	30
4.6	Significant Factors and Risks	30
5	Accessibility, Climate, Local Resources, Infrastructure and Physiography.....	32
5.1	Access.....	32
5.2	Climate	32
5.3	Local Resources and Infrastructures.....	33
5.4	Physiography	35
5.5	Fauna.....	35
6	History.....	36
6.1	Prior Ownership	36
6.2	Significant Historical Exploration Activities.....	36
6.3	Historical Resources	38
6.3.1	Pre-NI 43-101 Resource Estimates	38
6.3.2	NI 43-101 Compliant Resource Estimates by WGM.....	40
6.4	Production	41
7	Geological Setting and Mineralization	42
7.1	Regional Geology.....	42
7.2	Property Geology	42
7.2.1	General	42
7.2.2	Structure	45
7.2.3	Mineralization.....	45
8	Deposit Types	47
9	Exploration	48

CIMA+ M03802A



9.1	Historical Exploration	48
9.2	Rockex Exploration.....	48
10	Drilling.....	50
10.1	Historic Drilling	50
10.2	Algoma Drilling.....	50
10.3	Rockex 2008 Drill Program.....	51
10.4	Rockex 2011-2012 Drill Program	52
11	Sample Preparation, Analysis and Security	54
11.1	Sample Preparation and Analyses	54
11.2	Algoma Drill Program (1974-1975).....	54
11.3	2008 Drilling Program	54
11.4	2010 Historic Core Re-Sampling.....	55
11.5	Rockex' 2011-2012 Drilling Program	55
12	Data Verification.....	56
12.1	Historical Validation Work.....	56
12.2	Twin Drilling Program by Rockex (2008)	56
12.3	Re-Sampling of Algoma's 1974-1978 Core by Rockex (2010).....	56
12.3.1	Comparison of Rockex TotFe assays vs. Algoma SolFe Assays on Individual 10-ft Samples.....	57
12.3.2	Comparison of Rockex vs. Algoma Soluble Fe Assays.....	57
12.3.3	Comparison of Rockex XRF TotFe and Soluble Assays vs. Algoma Soluble Fe Assays.....	58
12.3.4	Comparison of Magnetic % Fe by Satmagan (Rockex) and Davis Tube Tests (Algoma)	58
12.3.5	Conclusions	58
12.4	Verification by WGM	59
12.5	Verification by Met-Chem	59
12.5.1	Database Validation – Spot Checks on 2008 and 2011-12 Data	60
12.5.2	Database Validation – 2008 Rockex Drill Program – QA/QC	60
12.5.3	Rockex 2008 Drill Program – XRF vs. Soluble Iron	61
12.5.4	Comparison of Satmagan (Rockex) Results vs. Davis Tube Tests (Algoma) on 2008 Samples.....	62
12.5.5	Cygnus' Work – 2011-2012 Drill Program	62
12.5.6	Site Visit.....	63
12.5.7	Core Review	64
12.5.8	Check Sampling.....	64

CIMA+ M03802A



13	Mineral Processing and Metallurgical Testing	69
13.1	Mineralogical Characteristics and Iron Department Study	69
13.2	Previous Test Work Programs	70
13.3	Summary of the Metallurgical Test Programs	70
13.3.1	Comminution Tests	71
13.3.2	Gravity Separation Tests	71
13.3.3	Magnetic Separation Tests	72
13.3.4	Desliming Tests	74
13.3.5	Flotation Tests	75
13.4	Conclusions and Recommendations	76
13.4.1	Conclusions	76
13.4.2	Recommendations	77
13.5	Future Test Work.....	77
13.5.1	Further Mineralogical Examination	77
13.5.2	Lock-Cycle Test Work.....	77
13.5.3	Pilot Plant Test Work	77
13.5.4	Comminution Test Work	77
13.5.5	Concentrate Slurry Transport Test Work	78
13.5.6	Concentrate and Pellet Feed Settling Test Work.....	78
13.5.7	Pellet Feed Filtration Test Work	78
13.5.8	Balling Design Parameter Test Work.....	78
13.5.9	Pot Grate Design Parameter Test Work	78
13.5.10	Wet High Intensity Magnetic Separation (“WHIMS”)	79
13.5.11	Hydraulic Separation Test Work	79
14	Mineral Resource Estimate	80
14.1	Mineral Resource Estimates Statement.....	80
14.2	Definitions.....	81
14.3	Mineral Resource Estimate Estimation Procedures	82
14.4	Drill Hole Database and Data Verification.....	82
14.4.1	Drill Hole Database	82
14.4.2	Data Verification	85
14.4.3	Geological Modelling Procedures	87
14.5	Statistical Analysis and Compositing	88
14.6	Variogram Modelling.....	92
14.7	Density/Specific Gravity	95

CIMA+ M03802A



14.8	Block Model Setup/Parameters	95
14.9	Structural Domains for Interpolation	96
14.10	Resource Interpolation	97
14.11	Resource Classification	99
14.12	Mineral Resource Statement	100
15.	Mineral Reserve Estimate	101
16	Mining Methods	102
16.1	Block Model	102
16.2	Pit Optimization	104
16.2.1	Pit Optimization Results.....	105
16.2.2	Cut-Off Grade	107
16.3	Mine Design	108
16.3.1	Material Properties.....	108
16.3.2	Geotechnical Pit Slope Parameters.....	108
16.3.3	Haul Road Design.....	109
16.3.4	Lake Elevation	109
16.3.5	Causeway Design.....	110
16.3.6	Dyke Design	110
16.3.7	Mine Dilution	112
16.3.8	Pit Design	113
16.3.9	Dump Design	114
16.4	Mine Planning	118
16.5	Mine Equipment Fleet	120
16.5.1	Haul Trucks.....	121
16.5.2	Shovels	122
16.5.3	Drilling and Blasting	122
16.6	Mine Dewatering	123
16.7	Manpower Requirements	123
17	Recovery Methods	125
17.1	Process Plant	125
17.1.1	Process Design Criteria	126
17.1.2	Flow Sheets and Process Description	127
17.1.3	Mass Balance and Water Balance.....	135



17.1.4	Equipment Sizing and Selection	136
17.1.5	Utilities	137
17.1.6	Power Requirements of Concentrator Plant and Sioux Lookout	137
17.1.7	Layouts	137
18	Project Infrastructure.....	139
18.1	General Arrangement	139
18.2	Lake St.-Joseph Area.....	141
18.2.1	Site Access and Roads.....	141
18.2.2	Security Gate House.....	141
18.2.3	Fuel Storage and Filling Station.....	142
18.2.4	Explosives Preparation and Storage	142
18.2.5	Accommodation Camp	142
18.2.6	Administration Building	142
18.2.7	Site Drainage and Settling Ponds.....	142
18.2.8	Helicopter Pad	143
18.2.9	Services	143
18.2.10	Communications	144
18.3	Concentrate Pipeline	145
18.4	Sioux Lookout Area	145
18.4.1	Security Gate House.....	145
18.4.2	Accommodation Camp	145
18.4.3	Administration Building	145
18.4.4	Site Drainage and Settling Ponds.....	145
18.4.5	Services	145
18.4.6	Communications	146
19	Market Studies and Contracts	147
19.1	Market Overview.....	147
19.2	Iron Ore Pricing for Project Financial Evaluation	148
20	Environmental Studies, Permitting and Social Community Impact.....	150
20.1	Environmental Studies	150
20.2	Permitting	151
20.3	Project Stakeholders	153
20.3.1	Aboriginal.....	154



20.4	Mine Closure and Rehabilitation	155
20.4.1	Introduction	155
20.4.2	Closure Cost	156
20.5	Recommendations	156
21	Capital and Operating Costs	158
21.1	Capital Cost Estimate	158
21.1.1	Scope of Estimate	158
21.2	Summary of the Capital Cost Estimate	159
21.2.1	Mine Capital Cost	159
21.2.2	Concentrator & Tailings	160
21.2.3	Mine Infrastructures	160
21.2.4	Concentrate Pipeline	161
21.2.5	Pellet Plant.....	161
21.2.6	Hot Briquetted Iron Plant	162
21.2.7	Railroad and Rail Yard.....	162
21.2.8	Sioux Lookout Infrastructures	162
21.2.9	Project Indirect Costs.....	163
21.3	Capital Cost Basis of Estimate	163
21.3.1	Currency Base Date and Exchange Rate	163
21.3.2	Items from the 2013 PEA.....	163
21.3.3	Additional item added to the project from original PEA	163
21.4	Mine Closure and Remediation Cost Estimate.....	163
21.5	Sustaining Capital Cost Estimate	164
21.6	Operating Cost Estimate	166
21.6.1	Scope and Methodology	166
21.6.2	Mine Operating Costs	166
21.6.3	Concentrating and Tailings Operating Costs	167
21.6.4	General and Administration Operating Costs	168
21.6.5	Rail Operating Costs.....	168
21.6.6	Pellet Plant Operating Costs.....	169
21.6.7	Briquetting Operating Costs.....	170
21.6.8	Manpower	171
22	Economic Analysis	172
22.1	Macro-Economic Assumptions	172

CIMA+ M03802A



22.2	Royalty and Impact and Benefit Agreements	173
22.3	Technical Assumptions	174
22.4	Financial Analysis Results	174
22.5	Sensitivity Analysis	176
22.6	Important Caution Regarding the Economic Analysis	181
23	Adjacent Properties	182
24	Other Relevant Data and Information	183
25	Interpretation and Conclusions	184
25.1	Mineral Resources	184
25.2	Mining Method	184
25.3	Processing and Metallurgy	184
25.4	Infrastructures	185
25.5	Environmental and Social Aspects	186
25.6	Economic Analysis	186
25.7	Risks	187
25.8	Conclusion	188
26	Recommendations	189
26.1	Mining and Geology	189
26.2	Metallurgy and Process	189
26.2.1	Further Mineralogical Examination	189
26.2.2	Lock-Cycle Test Work	189
26.2.3	Pilot Plant Test Work	190
26.2.4	Comminution Test Work	190
26.2.5	Concentrate Slurry Transport Test Work	190
26.2.6	Concentrate and Pellet Feed Settling Test Work	190
26.2.7	Pellet Feed Filtration Test Work	190
26.2.8	Balling Design Parameter Test Work	190
26.2.9	Pot Grate Design Parameter Test Work	191
26.2.10	Wet High Intensity Magnetic Separation ("WHIMS")	191
26.2.11	Hydraulic Separation Test Work	191
26.3	Environmental and Social Aspects	191
26.4	Infrastructures	192



26.5	Recommended Work Program and Estimated Costs	192
27	References	193

List of Tables

Table 1-1 – Comparison of the 3013 PEA with the 2015 Revised PEA	2
Table 1-2 – Rockex Lake St. Joseph Property, Eagle Island Deposit	8
– Summary of the Mineral Resources (Cut-Off of 10% Fe)	8
Table 1-3 – Summary of Capital Cost Estimate	14
Table 1-4 – Summary of an Average Year of Operations per Area	14
Table 1-5 – Summary of Financial Results.....	16
Table 2-1 – Responsibilities of Report Sections	21
Table 2-2 – Site Visits of the Qualified Persons.....	22
Table 4-1 – List of Claims for Rockex’ Lake St. Joseph Property	27
Table 5-1 – Kenora Average Weather by Month	33
Table 6-1 – Summary of Mineral Exploration and Development on the Lake St. Joseph Property	36
Table 6-2 – Historical Estimate of Iron Mineralization in the Fish Island and West Extension Areas (After Algoma, 1975).....	39
Table 6.3 – Mineral Resources Estimate by WGM (2011)*, Eagle Island Deposit	40
Table 7-1 – Regional Stratigraphy Column (after Stott, 1996)	44
Table 10-1 – Original and Twin Holes Drilled by Rockex in 2008	51
Table 12-1 – Comparison of Analytical Results for Duplicate Sample (Second Half-Core)	61
Table 12-2 – Main Statistical Parameters for the Algoma’s Soluble Iron Assays and Rockex’ Total Iron Assays.....	61
Table 12-3 – Analytical Results and Basic Statistics from Met-Chem’s QP Check Samples	65
Table 12-4 – Specific Gravity Determination on the QP Samples	67
Table 13-1 – Gravity Separation Amenability Testing Results	72
Table 13-2 – Grade/Recovery Results From a Multiple Pass Wilfley Table Test at -180 µm	72
Table 13-3 – Magnetic Separation Test Results	73
Table 14-1 – Summary of the Mineral Resources (Cut-Off of 10% Fe)	81
Table 14-2 –Compilation of Exploration Holes in the Database	83
Table 14-3 – Fields contained in the Drill Hole Database	86
Table 14-4 – Descriptive Statistics of Quality Elements in the Entire Database	87
Table 14-5 – Descriptive Statistics of Assays within the Iron Formation in the Main Zone	88
Table 14-6 – Descriptive Statistics of Assays within the Iron Formation in the South East Zone	89
Table 14-7 – Composites Statistics.....	90
Table 14-8 – Eagle Island – Blocks Model Parameters.....	96
Table 14-9 – Parameters of Structural Domains	97



Table 14-10 – Interpolation Parameters	98
Table 14-11 – Structural Domains for Resources Interpolation.....	98
Table 14-12 – Fe% Comparison for Assays, Composites and Blocks on Main Zone.....	99
Table 14-13 – Fe% Comparison for Assays, Composites and Blocks on South East Zone	99
Table 14-14 – Indicated Resources	100
Table 14-15 – Inferred Resources	100
Table 16-1 – Pit Optimization Parameters*	104
Table 16-2 – Pit Optimization Results	105
Table 16-3 – Material Properties	108
Table 16-4 – Dyke and Causeway Quantities	112
Table 16-5 – Tonnages and Grades by Phase.....	114
Table 16-6 – Mine Production Schedule (in '000,000 t).....	119
Table 16-7 – Mining Equipment Fleet.....	120
Table 16-8 – Truck Cycle Time.....	122
Table 16-9 – Truck Productivities (Year 5)	122
Table 16.10 – Blasting Parameters.....	123
Table 16-11 – Mine Manpower Requirements	124
Table 17-1 – Process Design Basis.....	126
Table 17-2 – Summary Process Mass Balance	136
Table 19-1 – DRI/HBI Production by Country/Region (Mtpy)	148
Table 20-1– Preliminary List of Provincial and Federal of Required Permits and Approvals	152
Table 20-2 – Accumulation Areas for Waste Rock Dump and Tailings Storage Facility	156
Table 21-1 – Summary of Capital Cost Estimate	159
Table 21-2 – Summary of Mine Capital Cost Estimate	160
Table 21-3 – Summary of Concentrator and Tailings Capital Cost Estimate.....	160
Table 21-4 – Summary of Mine Infrastructures Capital Cost Estimate	161
Table 21-5 – Summary of Mine Infrastructures Capital Cost Estimate	161
Table 21-6 – Summary of Hot Briquetted Iron Plant Capital Cost Estimate	162
Table 21-7 – Summary of Sioux Lookout Infrastructures Capital Cost Estimate.....	162
Table 21-8 – Summary of Capital Cost Estimate of the Indirect Costs.....	163
The sustaining capital cost estimates for the life of mine are summarized in the Table 21-9 to	164
Table 21-9 – Summary of Sustaining Capital Cost Estimate (Year 1 to 6)	164
Table 21-10 – Summary of Sustaining Capital Cost Estimate (Year 7 to 12)	164
Table 21-11 – Summary of Sustaining Capital Cost Estimate (Year 13 to 18)	165
Table 21-12 – Summary of Sustaining Capital Cost Estimate (Year 19 to 24)	165
Table 21-13 – Summary of Sustaining Capital Cost Estimate (Year 25 to 30)	165
Table 21-14 – Summary of Year 5 of Operations per Area	166
Table 21-15 – Summary of Year 5 of Operation for Mine Sector.....	167
Table 21-16 – Summary of Year 5 of Operation for Concentrating Sector	167



Table 21-17 – Summary of Year 5 of Operation for General and Administration Sector	168
Table 21-18 – Summary of Year 5 of Operation for Rail Sector	169
Table 21-19 – Summary of Year 5 of Operation for Pellet Plant Sector.....	169
Table 21-20 – Summary of Year 5 of Operation for Hot Briquetted Iron Plant Sector	170
Table 21-21 – Estimated Manpower Requirements (Year 5)	171
Table 22-1 – Macro-Economic Assumptions	172
Table 22-2 – Technical Assumptions	174
Table 22-3 – Summary of Financial Results.....	176
Table 22-4 – Cash Flow Statement.....	178
Table 25-1 – Summary of Financial Results.....	187
Table 26-1 – Recommended Work Program.....	192

List of Figures

Figure 4-1 – Site Location Map	25
Figure 4-2 – Claim Map	26
Figure 4-3 – Property Geology Map	28
Figure 12-1 – Analytical Results from QP Samples (Total Fe %).....	66
Figure 12-2 – Analytical Results from QP Samples (Soluble Fe%).....	66
Figure 13-1 – Gravity Separation Amenability Testing Flow Sheet	71
Figure 13-2 – Magnetic Separation Test Work Flow Sheet	73
Figure 13-3 – All-Desliming Test Flow Sheet as Used by Algoma in Their 1970s’ Test Work Program	74
Figure 13-4 – Desliming Fe Grade Versus Fe Recovery Results.....	75
Figure 13-5 – Flotation Grade Recovery Curves with the Corresponding All-Desliming Results	76
Figure 14-1 – Length Histogram for Davis Tube Composites Samples.....	84
Figure 14-2 – Sampling Length Histogram for Assays Within the 3D Solids	90
Figure 14-3 – Composites Histogram of % Fe on the Main Zone	91
Figure 14-4 – Composites Histogram of % Fe on the South East Zone	91
Figure 14-5 – % Fe Variogram Across the Strike Direction.....	93
Figure 14-6 – % Fe Variogram on N255°, Plunge of -80° (assumed as the dip direction)	94
Figure 14-7 – Fe% Combined Down Hole Variogram	94
Figure 14-8 – Regression between SG and Fe%	95
Figure 16-1 – Mine General Layout.....	103
Figure 16-2 – Pit Optimization Results	106
Figure 16-3 – Isometric View of PIT37	107
Figure 16-4 – Typical Section with Pit Shells	107
Figure 16-5 – Pit Wall Configuration	109
Figure 16-6 – Dyke Design.....	112
Figure 16-7 – Pit Layout (Phase 1).....	115
Figure 16-8 – Pit Layout (Phase 2).....	116



Figure 16-9 – Pit Layout (Final Design)117
 Figure 17-1 – Simplified Concentrator Flow Sheet129
 Figure 17-2 – Simplified Flow Sheet for Sioux Lookout Facility130
 Figure 17-3 – Hot Briquetting Process for Sioux Lookout HBI Plant Facility135
 Figure 17-4– Water Balance.....136
 Figure 17-5 – Concentrator General Arrangement, Plan View138
 Figure 18-1 – General Location Map.....140
 Figure 18-2 – General Arrangement of the Mine Site.....144
 Figure 18-3 – General Arrangement of the Sioux Lookout Site146
 Figure 19-1 - Iron ore price banks’ average forecast148
 Figure 19-2 - Pellet premium149
 Figure 19-3 - HBI price dynamics.....149
 Figure 22-1 – Before-tax Cash Flows and Cumulative Cash Flow.....175
 Figure 22-2 - Pre-tax NPV8%: Sensitivity to Pre-production Capital Cost, Operating Cost and Price179
 Figure 22-3 - Pre-tax IRR: Sensitivity to Pre-production Capital Cost, Operating Cost and Price179
 Figure 22-4 - Post-tax NPV8%: Sensitivity to Pre-production Capital Cost, Operating Cost and Price180
 Figure 22-5 - Post-tax IRR: Sensitivity to Pre-production Capital Cost, Operating Cost and Price180



List of Abbreviations

Abbreviations	Description
%	Percent Sign
°	Degree
°C	Degree Celsius
\$	Canadian dollar
\$/h	Canadian dollar per hour
\$/m ²	Canadian dollar per square meter
\$/m ³	Canadian dollar per cubic meter
\$/t	Canadian dollar per metric tonne
µm	Micrometer
-150 mesh	Minus 150 mesh
ARD	Acid Rock Drainage
ASL	Above Sea Level
BIF	Banded Iron Formation
BOF	Basic Oxygen Furnace
BWi	Bond Ball Work Index
CAD	Canadian dollar
CDE	Canadian Development Expenses
CEAA	Canadian Environmental Assessment Act
CEE	Canadian Exploration Expenses
CEPA	Canadian Environmental Protection Act
cfm	Cubic Feet per Minute
CFR	Cost and Freight (and port of destination)
CIF	Cost Insurance and Freight
CIM	Canadian Institute of Mining , Metallurgy and Petroleum
CIS	Commonwealth Independent States
cm	Centimeter
COV	Coefficient of Variation
CRM	Certified Reference Materials
DFO	Department of Fisheries and Oceans
DMT	Dry metric tonne
DRI	Direct Reduced Iron
DT	Davis Tube
EAF	Electric Arc Furnace
EPCM	Engineering Procurement Construction Management
EA	Environmental assessment
Fe	Iron
FOB	Free on board (and port of destination)
ft	Feet
g/cm ³	Gram per cubic centimeter
G&A	General and Administration
H ₂	Hydrogen

CIMA+ M03802A

ha	Hectare
HBI	Hor Briquetted Iron
HDPE	High Density Polyethylene
HmFe	Hematitic Iron
hp	Horsepower
HVAC	Heating, Ventilation, and Air Conditioning
ID	Identification
IDW	Inverse Distance Method
IDW2	Inverse Distance Squared Method
IRR	Internal Rate of Return
kg	Kilogram
kg/t	Kilogram per metric tonne
km	Kilometer
km ²	Square kilometer
km/h	Kilometer per hour
PEB	Pre engineered building
kV	Kilovolt
kW	Kilowatt
kWh/t	Kilowatt hour per tonne
L	Litre
LIMS	Low Intensity Magnetic Separator
LiDAR	Laser Illuminated Detection And Ranging
LOI	Loss on Ignition
LOM	Life of Mine
LSJI	Lake St. Joseph Iron Ltd.
LV	Low Voltage
m	Meter
M	Million
m ²	Square meter
m ³	Cubic meter
m/h	Meter per Hour
m ³ /h	Cubic meter per Hour
MagFe	Magnetic Iron
MCC	Motor Control Centre
MENA	Middle East and North Africa
min	Minutes
min/h	Minutes per hour
min/shift	Minutes per shift
mm	Millimeter
Mm ³	Million cubic meter
MNDM	Ministry of Northern Development and Mines
MNR	Ministry of Natural Resources Wildlife
MOECC	Ministry of Environment and Climate Change
MOU	Memorandum of Understanding
Mt	Million metric tonnes
Mtpa	Million tonnes per annum
Mtpy	Million tonnes per year
MV	Medium Voltage
MVA	MegaVolt-Ampere
MW	Megawatt

CIMA+ M03802A



MWh/d	Megawatt Hour per Day
MZ	Main Zone
M\$	Million Canadian dollars
M\$/y	Million Canadian dollars per year
NAG	Non Acid Generating
NAN	Nishnawbe-Aski Nation
NE	North East
NI 43-101	Canadian National Instrument 43-101
NPV	Net Present Value
NSR	Net Smelter Returns
NTS	National Topographic System
NW	North West
ON	Ontario
ORF	Ontario Research Foundation
PEA	Preliminary Economic Assessment
PF	Power Factor
ph	Phase (Electrical)
QA/QC	Quality Assurance /Quality Control
QP	Qualified Person
ROM	Run of mine
RQD	Rock Quality Designation
S	Sulfur
SAG	Semi-Autogenous Grinding Mill
SCIM	Squirrel Cage Induction Motors
SE	South East
SEZ	South East Zone
SG	Specific Gravity
SGS	SGS Mineral Services – Lakefield
S-L	Sioux Lookout
SMC	SAG Mill Comminution
SolFe	Sulfate Ferrous
SPI	SAG Power Index
SW	South West
t	Metric tonne
t/m ³	Metric tonne per cubic meter
TIN	Triangulated Irregular Network
TotFe	Total Iron
tpd	Metric Tonnes per Day
tph	Metric Tonnes per Hour
tpm	Metric Tonnes per Month
tpy	Metric Tonnes per Year
UMEX	Union Minière Exploration
USA	United States of America
USD or US\$	United States Dollar
UTM	Universal Transverse Mercator
V	Volt
VFD	Variable Frequency Drive
WGM	Watts, Griffis and McQuat
WHIMS	Wet High Intensity Magnetic Separation
WSD	World Steel Dynamics

CIMA+ M03802A



1 Summary

1.1 Executive Summary

CIMA+ was retained by Rockex Mining Corporation (CSE: RXM) ("Rockex") to prepare a Technical Report on the Updated Preliminary Economic Assessment ("PEA") including Hot Briquetted Iron ("HBI") Process for the Lake St. Joseph Project (the "Project"), located in northwestern Ontario. The updated PEA is based on the same basic mining method and processing flow sheet as utilized in the original study developed by Met-Chem in 2013 however, the updated PEA incorporates additional transformation of the final product, to produce 4.3 Mtpa of HBI at an expected metalization of 94% Fe. The Resource estimate performed by Met-Chem in the previous PEA remains valid. The Indicated Resources are estimated at 1,287 Million Metric Tonnes ("Mt") at a grade of 28.39% Fe, and the estimated Inferred Resources amount to 108 Mt grading 31.03% Fe. Met-Chem re-ran the pit optimization to reflect the production of HBI. This analysis resulted in no change to the optimized pit and therefore the same pit design and mine plan from the original PEA remain unchanged. The mine plan developed by Met-Chem in the previous PEA, provided a feed to the concentrator to produce 6 Mtpa of pellet feed concentrate, during a 30 year Life of Mine ("LOM"). The pit includes 512 Mt of Mineral Resources with an average Fe grade of 28.9% and has a strip ratio of 0.51:1 with 26 Mt of overburden and 233 Mt of waste rock. Only 1.4% of the Mineral Resources contained within the pit are in the Inferred category. The metallurgical test were performed by SGS and supervised by Met-Chem. The concentrator process was developed by Met-Chem in the previous PEA and Cima+ reviewed the process development for this update. The pellet plant and the HBI plant were developed by Danieli, a technology supplier, and the integration to the updated PEA was completed by Cima+. The environmental considerations and permitting was prepared by Met-Chem in the previous PEA and was reviewed by Cima+ for this updated report. The capital and operating cost developed by Met-Chem for the previous PEA and Danieli for the pellet and HBI plant have been reviewed by Cima+ and adapted to reflect an integrated project. The estimated Capital Cost is M\$3,772 and the average Operating Cost is \$135.35/ tonne of HBI. The Economic Analysis, developed by Michel L. Bilodeau demonstrates, at a selling price of US\$350/t of HBI FOB Sioux-Lookout, the following economical value:

- IRR of 22.5% (Pre Tax) and 19.5% (Post Tax);
- Payback of 3.7 years (Pre Tax) and 4.1 years (Post Tax);



- NVP at 8% of 6,577.5 M\$ (Pre Tax) and 4,672.6 M\$ (Post Tax).

The updated PEA (2015) is based on the same basic mining method and processing flow sheet utilized in the original (2013) PEA; however, the updated PEA evaluates the economic impact of further processing the mine's production to HBI as an end product in place of Pellet Feed concentrate. As illustrated in Table 1-1, the PEA (2015) further improves the project economics relative to the previous study.

Table 1-1 – Comparison of the 2013 PEA with the 2015 Revised PEA

Item	PEA 2013	Updated PEA 2015	
Production Rate			
Pellet Feed Concentrate (Mtpa)	6.0	6.0	
Pellet (Mtpa)	-	6.1	
HBI (Mtpa)	-	4.3	
Projected Mine Life (yrs.)	30	30	
Commodity Price Assumption			
Pellet Feed, FOB Sioux-Lookout (\$US/t)	105	-	
HBI, FOB Sioux-Lookout (\$US/t)	-	350	
LOM Revenue (M\$)	19,811.8	52,682.6	
Initial Capital (M\$)	1,558.8	3,772	
Working Capital (M\$)	48.1	129.6	
Sustaining Capital (M\$)	543.3	538.3	
Closure Cost (M\$)	65.7	65.7	
Average Operating Costs	\$/t of pellet feed	\$/t of pellet feed	\$/t of HBI
Mining cost	12.76	12.76	17.88
Concentrator & tailings cost	18.05	18.05	25.29
Concentrate dewatering cost	1.83	-	-
Railroad	0.20	0.20	0.28
General & administration cost	3.79	4.52	6.33
Pelletizing cost			19.13
Briquetting cost			66.44
Total Operating Cost (\$/tonne)	36.63	-	135.35

CIMA+ M03802A



Item	PEA 2013	Updated PEA 2015
Manpower Requirements		
Mine	180	180
Concentrating & Tailings	114	114
Concentrate dewatering	36	-
General & administration	49	89
Rail	6	6
Pelletizing		127
Briquetting		200
Total Manpower	385	716
Pre-Tax Economic Indicators		
NPV @ 8%	2217.2	6577.5
IRR (%)	20.7	22.5
Payback (yrs)	4.2	3.7
Post-Tax Economic Indicators		
NPV @ 8%	1553.7	4672.6
IRR (%)	18.1	19.5
Payback (yrs)	4.4	4.1

1.2 Property Description and Ownership

Rockex' Lake St. Joseph Iron Property consists of 13 contiguous mining claims covering an area of 2,592 ha. The Property is located in the Patricia Mining Division, in the Province of Ontario, Canada, approximately 100 km NE of Sioux Lookout and 80 km SW of Pickle Lake. The Property encompasses the deposits of Eagle, Wolf and Fish Islands and covers the southwestern part of Lake St. Joseph. Rockex acquired the claims from Pierre Gagné in 2008. The claims are currently active and Rockex is the 100% recorded holder of all 13 claims. The Property is subject to an Iron Royalty Agreement providing for a 2% royalty of the gross sale proceeds from any and all minerals mined and processed for their iron content or, starting in 2012, an annual advance royalty of \$250,000 per year (increasing at a rate of 10% per year) in the event that there is no commercial production from the Property. Pursuant to a cross-credit clause, advance royalty payments payable are credited against royalties payable from commercial production. The Property is also subject to a NSR Royalty Agreement which provides for 2% net smelter returns royalty payable on any and all other



minerals produced (i.e. excluding those produced for their iron content) commencing on commercial production.

1.3 Geology and Mineralization

The Property is situated in the Lake St. Joseph Archean greenstone belt of the Uchi Subprovince of the Canadian Shield. In the Lake St. Joseph area, volcanic rocks are overlain by a suite of clastic and chemical sedimentary rocks that form the Eagle Island assemblage, which hosts the iron formation on the Property.

The Lake St. Joseph mineralization is considered to be iron formation of the Algoma-type, although the iron formation units are interlayered with beds of sedimentary rocks. The iron formation occurs as an east-west trending, steeply plunging syncline refolded in a pair of sub-parallel anticlines on Eagle Island. The iron formation extends from Eagle through Fish and Wolf Islands, and further west across the Property.

The iron mineralization consists of a fine-grained, massive mixture of specular hematite and magnetite or of well-banded magnetite beds containing very little hematite component alternating with quartz-chert beds. The ratio of hematite to magnetite in the iron formation may vary in different parts of the Property. The gangue consists of sericite, biotite, chlorite, carbonate with some hornblende and apatite. Some layers contain minor pyrite or pyrrhotite, but the sulphide content of the iron formation is generally sparse in the current mineral resource area.

1.4 Status of Exploration, Development and Operations

The Property is at a relatively advanced stage of development, with sufficient exploration and drilling data for the iron mineralization in the Eagle Island area to support a mineral resources estimate that formed the basis of the previous and present PEA. No production of iron mineralization has been reported for the Property.

1.5 Mineral Processing and Metallurgical Testing

The metallurgical test program undertaken for the the Rockex iron deposits had the mandate to characterize the deposits from a processing and metallurgical point of view, and to design a process flow sheet capable of production of iron concentrate of the following parameters: Fe grade above 65%, SiO₂ near 5%, Fe Recovery near 80% from Eagle Island mineralization, maximising the weight recovery.



To develop the concentrator flow sheet, a detailed metallurgical test program was performed at the SGS facilities in Lakefield, ON under the supervision of Met-Chem. Most of the test results were positive and successful proving the efficiency and applicability of certain equipment: SAG mills, ball mills, gravity concentration using spirals and magnetic separators and desliming.

The tests at SGS confirmed that conventional gravity and magnetic separation will efficiently and effectively concentrate the iron bearing minerals as well.

The mineralization as tested based on the samples provided does require complex treatment for successful beneficiation. Some of the silica and fine iron silicates are eliminated simply by using spiral concentration. However, further fine grinding and magnetic separation processes are required to maximize the weight recovery of the final concentrate.

Based on the successful tests and the results from the metallurgical test program a dedicated process flow sheet was developed and designed. This will allow Rockex to process the Run of Mine (“ROM”) mineralized material to a pulp of size, sufficient to achieve the liberation of the gangue minerals and produce a concentrate with metallurgical parameters and purity requirements of the iron industry.

1.5.1 Comminution Tests

Preliminary test work included Bond Ball Work Index (“BWi”) test and SAG Power Index (“SPI” ® Test) to establish the grinding power requirements. The SPI is an indication of the amount of energy required in primary grinding systems. SPI 37.3 minutes, which is equivalent to a specific grinding energy in the SAG mill of 8.12 kWh/t. The BWi, an indication of the amount of energy required in a ball mill grinding system, was measured to average 10.6 kWh/t.

1.5.2 Gravity Separation Tests

The mineralogical characterization indicates that the silicates become liberated at a size much coarser than the iron oxides. In order to determine if silicates could be rejected at a coarser size grind, Wilfley table testing was performed at three (3) grind sizes, P₁₀₀ of 1,700, 600 and 180 µm respectfully.

The results of the gravity amenability test program reveal that between Stage I and II, 15% weight can be rejected with an 8.1% loss in iron. Stage III showed promising results concerning its ability to make a



concentrate (16.7% weight at 57.2% Fe grade). Further test work at $-180\ \mu\text{m}$ was pursued for both tailings rejection and concentrate production.

A grade recovery curve was produced by performing multiple passes on a Wilfley Table. The target grind was a P_{100} of $180\ \mu\text{m}$, with the resulting P_{80} being $88\ \mu\text{m}$.

1.5.3 Magnetic Separation Tests

Magnetic separation testing was performed at a fine grind size, i.e. a P_{100} of $38\ \mu\text{m}$. The magnetic intensity was low and was targeting the ferromagnetic iron oxide mineral (magnetite) in the feed. The hematite predominately reports to the non-magnetic fraction of the test work. The feed was ground to $-38\ \mu\text{m}$ and subjected to a rougher Low Intensity Magnetic Separation (“LIMS”) circuit consisting of one (1) stage of counter current and two (2) stages of concurrent. The rougher concentrate was reground to $-25\ \mu\text{m}$ and submitted to one (1) stage of concurrent magnetic separation. The finishing concentrate was then deslimed producing a final tail.

51.6% of the Fe is recovered in the rougher stage with a corresponding grade of 57.3% Fe. The regrinding of the concentrate further liberates the magnetite from both hematite and silicates making a finishing concentrate with a grade of 63.9% Fe with a Fe recovery of 50%. The final desliming step was necessary to make a concentrate with a grade above 65% Fe. The desliming tails contained 0.8% of the overall Fe content with a corresponding weight of 1.34%; the final concentrate had a 66.9% Fe grade.

1.5.4 Desliming Tests

Eight (8) tests were conducted, out of which three (3) reached the SiO_2 target of near or below 5%. The final grind size to liberate the silica and ranged from a P_{80} of $20\ \mu\text{m}$ to about $25\ \mu\text{m}$ (100% passing $38\ \mu\text{m}$). The highest Fe grade was achieved in AL-DES-08 with 66.9% Fe and a corresponding recovery of 71.6% Fe.

1.5.5 Flotation Tests

In order to evaluate the possibility of further increasing the grade of the concentrate, reverse silica flotation was performed upon concentrates produced during desliming test work. Flotation produced concentrates with a Fe grade above 67% and a SiO_2 grade below 3% while the corresponding Fe recoveries ranged between 50 to 70. The fine size of the material poses a challenge to selectivity of the flotation as a process. More depression of the iron is needed in order to improve the Fe recovery. Throughout the flotation test



work, a high degree of agglomeration was observed. This agglomeration may be due to magnetic attraction and demagnetizing the pulp prior to flotation should be investigated. It may also be possible to improve Fe recovery with the addition of scavenger stages on the silicate flotation product. Further optimisation of the flotation test work is warranted as it may improve overall results.

1.6 Mineral Resource Estimate

The updated mineral resource estimate by Met-Chem included the data from the drill holes completed in 2008 and 2011-2012 that were not available to Watts, Griffs and McOuat (“WGM”). The geological interpretation and 3D model was updated accordingly. The estimate was done in accordance with NI 43-101 regulation and the guidelines on the resource classification adopted by the Council of the Canadian Institute of Mining, Metallurgy and Petroleum (November 2010).

The database included a combination of assays for soluble iron performed by acid digestion and titration (Algoma’s 1974-1978 drill holes) and total iron determination by meta-borate fusion and XRF analysis.

Rockex’ re-sampling program was designed to validate the data generated by Algoma, and showed that the two (2) methods gave the same results, which allowed Met-Chem to include the older data in to the database for use in the resource estimate.

Variograms were generated in order to analyse the spatial continuity of the mineralization and determine the suitable parameters for grade interpolation. Met-Chem created a regression model between density and the iron content and assigned these values to the block model.

A block model was created using MineSight® software package to generate a grid of regular blocks for estimating tonnes and grades. Regular 50 m by 50 m by 10 m block sizes were used.

The resources of the Eagle Island deposit were estimated using the Inverse Distance Squared Method (“IDW2”), and are reported to a cut-off grade of 10% Fe and are not constrained to a pit.

The resource was estimated for the portion of the iron formation located on Eagle Island and is summarized in Table 1-2.

**Table 1-2 – Rockex Lake St. Joseph Property, Eagle Island Deposit
 – Summary of the Mineral Resources (Cut-Off of 10% Fe)**

Category	Tonnage (MT)	Fe (%)
Indicated	1,287	28.39
Inferred	108	31.03

The estimate of Mineral Resource may be materially affected by environmental, permitting, legal, title, socio-political, marketing, or other relevant issues. However, Met-Chem is not aware of any known issues that would materially affect the mineral resource.

The estimate for the tonnage and grade of Inferred Resources is based on limited information and sampling gathered through appropriate techniques from locations such as outcrops, trenches, pits, workings and drill holes. Due to the uncertainty that may be attached to Inferred Mineral Resources, it cannot be assumed that all or any part of an Inferred Mineral Resource will be upgraded to an Indicated or Measured Mineral Resource as a result of continued exploration.

However, it is important to note that the estimated resources in the Inferred category for the Eagle Island deposit only represent a small percentage (7.7%) of the total resources.

1.7 Mineral Reserve Estimate

Since this report is a Preliminary Economic Assessment report, no Mineral Reserves are estimated. The Mineral Resources have been classified as In-pit Mineral Resources.

1.8 Mining Methods

Met-Chem evaluated the potential for an open pit mine at Eagle Island to produce 6 Mt of iron pellet feed per year which will then be converted into 4.3 Mt of HBI. The Mineral Resources used for the PEA are based on the resource estimation completed by Met-Chem which is discussed in this Report.

Since this Study is at a PEA level, NI 43-101 guidelines allow Inferred mineral resources to be used in the optimization and mine plan.

The mining method selected for the Project is a conventional open pit drill and blast operation with rigid frame haul trucks and hydraulic shovels. Vegetation, topsoil and overburden will be stripped and stockpiled for future reclamation use. The mineralization and waste rock will then be drilled, blasted and loaded into



haul trucks with hydraulic shovels. In order to access the pit, a 1.3 km long causeway will be constructed to connect the south shore of Lake St. Joseph to Eagle Island. A series of dykes will also be constructed to permit dewatering of the dyked area to provide access to the mineral resources that lie beneath the lake.

The pit design and mine plan are limited to a 30-year mine life for the PEA, even though there are sufficient mineral resources for a longer period. The 30-year pit that has been designed for the Eagle Island deposit is approximately 2,000 m long and 900 m wide at surface with a maximum pit depth of 400 m.

The pit includes 512 Mt of Mineral Resources with an average Fe grade of 28.9% and has a strip ratio of 0.51:1 with 26 Mt of overburden and 233 Mt of waste rock. Only 1.4% of the Mineral Resources contained within the pit are in the Inferred category.

A production schedule (mine plan) was developed for the Eagle Island Project to produce 6 Mt of iron pellet feed per year. Using the mill recovery of 80% and a targeted pellet feed grade of 66.3% results in an average run of mine feed of 17.3 Mt per year at an average Fe grade of 28.9%.

The pit will be developed in three (3) phases in order to delay the dyke construction and lake dewatering. In phase 1 (years 1 to 2), the mine can be operated without the need for dyking. Phase 2 (years 3 to 8) requires a short temporary dyke and Phase 3 (years 9 to 30) requires the final dyke.

The fleet of equipment will include 14 rigid frame haul trucks (218 tonnes payload), two (2) hydraulic excavators (70 tonnes bucket), two (2) drills as well as a fleet of support equipment and service vehicles.

1.9 Recovery Methods

The process design and the resulted processing flow sheet for the Lake St Joseph Project processing plant is based on and specifically performed for the project metallurgical test program and benchmarks from nearby developing projects.

1.9.1 Concentrator

Test work program was undertaken at SGS Lakefield and the summarized flow sheet is therefore presented in this Report. Run of mine (“ROM”) material is crushed using gyratory crusher before being hauled to the concentrator plant. Met-Chem has included the use of standard SAG mill with screening to produce a P 80 of 1,700 µm. The SAG mill screen undersize is pumped to three (3) parallel closed-loop ball mill circuits.



The cyclone overflow of each ball mill circuit, with a P_{80} of 88 μm , is pumped to three (3) gravity separation circuits each composed of two (2) stages of spiral gravity separators, rougher and cleaner.

The rougher tails are final tails. The rougher concentrate is fed to the cleaner spirals. The cleaner concentrate represents the final concentrate. The cleaner tailings are pumped to the tertiary grinding circuits to liberate magnetite particles that are associated with silica. Tertiary grinding circuits include two (2) closed-loop ball mill circuits with cyclones. The cyclones overflow, with a P_{80} of 27 μm , is directed to low intensity rougher and cleaner magnetic separators ("LIMS"). The concentrate from the rougher and cleaner LIMS is directed to a final stage of grinding. As a final liberation step, the finisher ball mill operates in closed circuit with cyclone. The cyclone overflow, with a P_{80} of 18 μm , is further concentrated by low intensity finisher magnetic separators and is pumped to a desliming thickener. The magnetite concentrate from desliming thickener underflow is a final concentrate and is pumped to the final concentrate (pellet feed) thickener.

It is important to note that the concentrator product is a concentrate however if it is fine enough to be fed directly to a pellet plant without further grinding it is generally called pellet feed. Generally concentrate will be used in description of the test work, flow sheet and concentration processes up to the final concentrate.

1.9.2 Pellet Plant

Bentonite will be used as the pelletizing binder. Bentonite will be reclaimed from a bentonite storage facility and charged to a storage bin in the grinding building. It will be withdrawn by belt feeder and fed to a vertical roller mill. Based on the needs and requirements, limestone will be ground to pelletizing fineness in a wet ball mill in closed circuit with hydrocyclones. This flux will be reclaimed from limestone stockpile and conveyed to a storage bin.

The concentrate slurry will be received at the pellet plant at approximately 65% by weight of solids from a pipeline. The slurry will be fed directly to the slurry tank. The slurry tank have a total maximum storage of 8 hours. The concentrate is pumped to a pressure distributor and dewatered in six (6) vacuum disc filters (and a seventh filter on standby). Six (6) vacuum pumps will be provided. Three (3) snap blow compressors, also common to all filters, will provide air for cake release. The filter cake is transferred via conveyor to the filter cake bins in the mixing station. Filtrate and filter boot drain is pumped back to the thickener. Distributor and filter boot overflow slurry is returned by gravity to the filter feed tank.



The bentonite will be fed to the mixer feed by a screw feeder. Concentrate is withdrawn from cake bins by feeders and discharged into the mixer. The filter cake and binder are mixed in a horizontal mixer. A spare mixer is provided in case of break down. The mixed material will be transported by belt conveyor to the balling area. Reject green balls from the green ball screening system will be added to the mixed material downstream of the mixer.

Product pellets discharged from the segregation bin will be transported by conveyor to the pellet stockyard.

The estimated stockpile area has 2 stockpiles for a total size of 150 m x 1,200 m, to handle production of 6 Mtpy and storage. Pellet products will be reclaimed by a slewing type bucket reclaimer. The reclaimed iron pellet products will be transported from the stockpile to the car loader by a conveyor system operating at 3,000 tph.

1.9.3 Hot Briquetted Iron (HBI) Plant

The Rockex HBI Plant will utilise gas-based direct reduction processes and will have capacity of 4.3Mtpa at an expected metalization of 94% Fe. The Pellet product is fed to a shaft-based reduction furnaces. The feedstock is prepared to adjust the size to the required in the reduction furnace. This requires screening for separation to adjust the particle size downward.

The process gas is formed to generate H₂ and CO to remove the oxygen from the ore. Natural gas enters the reduction furnaces and is heated to the required temperature for reduction of the oxide feed.

Once reduced, the product is hot briquetted to produce the HBI (hot briquetted iron) and then cooled prior to storage in piles. The hot briquetting is performed in a shaft-based furnace, where the pellets product is introduced through a proportioning hopper at the top of the shaft furnace. As the ore descends through the furnace by gravity flow, it is heated and the oxygen is removed from the iron (reduced) by counter flowing gases, which have a high H₂ and CO content. With a screw the hot feed is pushed into the nip between two counter rotating rollers of the briquetting machine. Pockets in the synchronously rotating rollers form the briquettes. This process occurs at high temperatures (700 °C) and high pressing forces (120 kN per cm active roller width). The continuous string of briquettes leaving the rollers is guided by a heavy chute and is separated into mostly singles for example by a rotor with impact bars. Briquettes from fine material, produced in fluidized bed processes, may also be separated in a rotating tumbling drum.

The entire plant for the hot briquetting consists of:

- Briquetting press with screw feeder and material supply
- Briquette string separator (impact separator or tumbling drum)
- Hot screen for the elimination of fines which occur during briquetting and separation
- Product cooler
- Bucket elevator for the recirculation of fines to the briquetting press
- Chutes and accessories

1.10 Project Infrastructure

The Lake St. Joseph Iron Property is located 100 km northeast of the town of Sioux Lookout, Ontario. The open pit, waste and overburden dumps are located on the eagle island. The concentrator, accommodation camp, offices and workshops, are located on the south shore of the Lake St. Joseph. Drainage ditches will be constructed around the open pit and dumps to direct water runoff to settling ponds to avoid contamination. The mineralized material will be hauled by the mine haul trucks to the gyratory crusher via the causeway that will link the island and the south shore. A haulage road will be constructed between the mine and the crushers. The mine facilities will produce 6 Mt of iron concentrate annually. The concentrate will be conveyed into a slurry by the concentrate pipeline to Sioux Lookout.

At Sioux Lookout, the concentrate will be dewatered, pelletized, and briquetted to be shipped by rail. The pellet plant, the hot briquetted iron plant, offices, workshop, gas separation plant and train load-out are located on the same processing complex east of Sioux-Lookout.

The CN Rail mainline network is located in the centre of the town of Sioux-Lookout. The CP Rail network is located 70 km south of Sioux-Lookout, providing an opportunity to conduct future trade off studies to determine which network will service the project.

1.11 Market Studies and Pricing

The estimation of the selling price is based on the forecast of Metalloinvest, a world leading producer of HBI. For the PEA Study, the long term price of HBI is forecasted at US\$350/t FOB Sioux Lookout, rail loading yard.



1.12 Environmental Studies, Permitting and Social Community Impact

The Project will be subject to an Environmental Assessment (“EA”) in accordance with provincial and federal requirements. Following release from the provincial and federal EA processes, the project will require a number of approvals, permits and authorizations prior to initiation and throughout all stages in the life of the project. In addition, Rockex will be required to comply with any other terms and conditions associated with the EA release issued by the provincial and federal regulators. Additional details are provided in Section 20.

1.13 Capital and Operating Costs

The capital cost of the project is the cost for the initial development of the project. Table 1-3 summarizes the capital cost estimate.



Table 1-3 – Summary of Capital Cost Estimate

Description	Cost (\$'000)
Direct Cost	
Causeway	12,144
Mine	137,246
Concentrator & Tailings	501,838
Mine Infrastructures	78,843
Concentrate Pipeline	218,173
Pellet Plant	832,481
Hot Briquetted Iron Plant	1,550,000
Rail and load-out	4,260
Sioux Lookout Infrastructures	76,756
Total Direct Cost	3,411,741
Indirect Costs	
Project Indirect	154,389
Contingency	205,852
Total Indirect Cost	360,241
Total Project Cost	3,771,982

The summary of the annual costs and unit costs per tonne of hot briquetted iron (HBI) of an average year of operations, are summarized in Table 1-4.

Table 1-4 – Summary of an Average Year of Operations per Area

Area	Annual Cost (\$'000)	Unit Cost (\$/t HBI)
Mining	76,560	17.88
Concentrating & Tailings	108,285	25.29
General and Administration	27,108	6.33
Rails	1,200	0.28
Pelletizing	81,918	19.13
Briquetting	284,441	66.44
TOTAL	579,512	135.35

CIMA+ M03802A



The capital expenditures during the life of the mine (“the Sustaining Capital”) are required to maintain or upgrade the existing asset and to continue the operation at the same level of production. They are charged as an operating cost and are outlined in Table 21-9 to Table 21-13.

Mine closure costs for the Project are estimated at approximately M\$65.7 spread over three years and must be secured in a trust fund at the beginning of mining operations. It is assumed that trust fund payments are made in the last pre-production year and in the first two years of operation in the proportions of 50/25/25 %, respectively.

1.14 Economic Analysis

An economic/financial analysis has been carried out for the Lake St. Joseph Project (Eagle Island deposit) using an annual concentrate production rate of 6 Mt further processed into 4.3 Mtpa of hot briquetted iron (HBI) at an expected metalization of 94% Fe. The project’s life is limited to 30 years of production.

A cash flow model is constructed on an annual basis in constant money terms (second quarter 2015). No provision is made for the effects of inflation. The Project is assessed on a “100%-equity” basis (i.e. unlevered cash flows) in conjunction with a discount rate that represents the cost of equity capital.

A long-term FOB Sioux Lookout price of 350 USD/t of product is assumed, the location from which it is to be sold to potential customers. A long-term exchange rate of 0.85 USD/CAD is assumed over the life of the Project.

The summary of the economic analysis is shown in Table 1.5.



Table 1-5 – Summary of Financial Results

Description	Units	Value
Total FOB Revenue	M\$	52,682.6
Total Operating Costs (including royalty)	M\$	18,376.4
Total Pre-Production Capital Costs (excluding Working Capital)	M\$	3,772.0
Total Sustaining Capital Costs	M\$	538.3
Total Closure Costs	M\$	65.7
Salvage Value	M\$	187.8
PRE-TAX		
Total Cash Flow	M\$	30,118.0
Payback Period	Years	3.7
Net Present Value @ 8%	M\$	6,577.5
Net Present Value @ 6%	M\$	9,421.1
Net Present Value @ 10%	M\$	4,603.8
Internal Rate of Return	%	22.5
POST-TAX		
Total Cash Flow	M\$	22,579.5
Payback Period	years	4.1
Net Present Value @ 8%	M\$	4,672.6
Net Present Value @ 6%	M\$	6,850.0
Net Present Value @ 10%	M\$	3,158.2
Internal Rate of Return	%	19.5

The economic analysis contained in this report is preliminary in nature. It incorporates inferred mineral resources that are considered too geologically speculative to have the economic considerations applied to them that would enable them to be categorized as mineral reserves. It should not be considered a prefeasibility or feasibility study. There can be no certainty that the estimates contained in this report will be realized. In addition mineral resources that are not mineral reserves do not have demonstrated economic viability.

1.15 Recommendations

1.15.1 Geology

The exploration and drilling data available for the portion of the iron formation located on Eagle Island are sufficiently complete and adequate to support the estimation of the mineral resources that served as the basis of the present PEA. The Indicated Resources of the present estimation are adequate for the purposes



of a pre-feasibility study. The resources in the Inferred category cannot be used in a pre-feasibility study, however they only represent a small percentage (7.7%) of the total resources.

1.15.2 Mining

The following activities should be considered to support a pre-feasibility study:

- A more detailed survey should be carried out to determine the topographic elevations on Eagle Island, the thickness of overburden and the elevation of the lake bottom;
- Geotechnical and hydrogeological studies should be performed to further confirm rock slopes, rock permeability, ground and underground water flows in order to validate the open pit mining technical parameters;
- The maximum lake elevation should be reconfirmed with Ontario Hydro since the current letter dates from 1969;
- An in-depth geotechnical study should be carried out to validate the dyke design parameters.

1.15.3 Metallurgy

To improve the iron recovery while maintaining the iron content above 65% and SiO₂ below 5%, and in order to attain the next level of study, the following test works are recommended.

1.15.3.1 Further Mineralogical Examination

Additional and more detailed mineralogical examination by X-ray powder diffraction, optical microscopy, micro-probe and Quantitative Evaluation of Minerals by Scanning electron microscopy (QEMSCANTM) to be performed on new representative samples to confirm the material properties of the ore.

1.15.3.2 Lock-Cycle Test Work

The various stages of the process need to be tested in combination to determine how the processes combine together. A lock-cycle is required to determine overall process recovery and concentrate grade.

1.15.3.3 Pilot Plant Test Work

The pilot plant data will give significant amounts of additional data. Since this mineralization type is complex in nature, this step is of major importance to validate the adopted flow sheet.

1.15.3.4 Comminution Test Work

To improve the accuracy of the SAG mill sizing in the pre-feasibility phase, crushing and grinding test work is recommended to evaluate the variability of the mineralization. Existing drill core samples should be used for this purpose. A JK Drop Weight Test should be performed on a representative composite of the mineralization as it will be mined while SMC Tests should be performed on the lithologies present to gauge the variability of the deposit.

1.15.3.5 Concentrate Slurry Transport Test Work

As this section will be a major expense, for the pre-feasibility study, slurry transport testing should be performed. Due to the fine nature of the pellet feed, rheology testing is needed especially with a focus on the effect due to changes in pulp density.

1.15.3.6 Concentrate and Pellet Feed Settling Test Work

For the pre-feasibility study, settling testing for thickeners should be done. This can be done using a testing laboratory or a vendor facility.

1.15.3.7 Pellet Feed Filtration Test Work

For the pre-feasibility study, testing for filtration equipment should be done.

1.15.3.8 Balling Design Parameter Test Work

Balling test work is suggested, but not required for pre-feasibility. The balling design parameters should comprise:

- Green pellet chemical analysis (including but not limited to the content of water, magnetite, hematite, elemental iron, dolomite, limestone, hydrated lime, blast furnace slag or scale and recycle fired pellets);
- Green pellet physical analysis (including green pellet size distribution, crushing strength, tumbler strength, porosity, specific gravity and bulk density).

1.15.3.9 Pot Grate Design Parameter Test Work

Pot Grate testing is suggested, but not required for pre-feasibility. To provide prospective customers with a proven quality product, balling and pot grate test work should be done. The pot grate design parameters test work should be based on fired pellets and include:

- Pre-heating (drying) time, temperature, air flow and heat requirements;
- Induration (cooking) time, temperature, air flow and heat requirements;
- Cooling time, temperature, air flow and heat requirements;
- Optimal hearth layer thickness for the above;
- Fired pellet physical analysis (including fired pellet size distribution, crushing strength, tumbler strength, porosity, specific gravity and bulk density);
- Fired pellet chemical analysis (including assay results of fired pellet and analytical results of the minerals and mineralogical structure);
- Fired pellet metallurgical test work results (including reducibility, swelling reduction and softening).

1.15.3.10 Wet High Intensity Magnetic Separation (“WHIMS”)

Testing of the tails from the LIMS circuit with a high intensity type of separation equipment should be further investigated. Due to the fine nature of the material at its liberation size, a SLON is the suggested device.

1.15.3.11 Hydraulic Separation Test Work

Testing of the material with a hydraulic classifier at coarser size range and a reflux classifier at the finer size range may provide similar/better results than the desliming circuit.

1.15.4 Environment and Social Aspects

With respect to environmental considerations, we recommends to:

- Carry out the Environmental Assessment as well as any related environmental baseline studies;
- Engage in discussions with local community and include additional stakeholders to identify key areas and subjects to be addressed during the advancement of the exploration project and through the future EA phase of the Project; and
- Conduct geochemical testing to determine Acid Generating/Non-Acid Generating Potential of mineralized waste rock and tailings as well as the respective potential for metal leaching/non leaching.

1.15.5 Infrastructure

- Initiate discussions with electric power company to confirm the power supply options.

2 Introduction

2.1 Scope of Study

This Technical Report presents the results of the Updated Preliminary Economic Assessment including HBI Process for the Lake St. Joseph Iron Project. The Project is entirely located in northwestern Ontario, approximately 100 km northeast of Sioux-Lookout, Ontario. In May 2015, Rockex mandated CIMA+ to prepare the PEA Updated Study. The services of Met-Chem were retained to produce the mineral resource estimate, to provide the mine plan and the in-pit resource estimate, metallurgical testwork supervision for the concentrator, concentrator process development and the environmental considerations and permitting. The preliminary economic analysis was prepared by Mr. Michel L. Bilodeau.

This Report titled “Technical Report on the Updated Preliminary Economic Assessment including HBI Process for the Lake St. Joseph Iron Project” was prepared by CIMA+ with contributions by Met-Chem. The report follows the guidelines of the “Canadian Securities Administrators” National Instrument 43-101 (effective July 31, 2015), and is in conformity with the guidelines of the Canadian Institute of Mining, Metallurgy and Petroleum (“CIM”) Standard on Mineral Resources and Reserves. Table 2-1 shows the responsibilities for each section of the report.



Table 2-1 – Responsibilities of Report Sections

Report Section	Responsible	Comment
Section 1 - Summary	JST	And other
Section 2 - Introduction	JST	
Section 3 - Reliance on Other Experts	JST	
Section 4 - Property Description and Location	YAB	
Section 5 - Accessibility, Climate, Local Resources, Infrastructure and Physiography	YAB	
Section 6 - History	YAB	
Section 7 - Geological Setting and Mineralization	YAB	
Section 8 - Deposit Type	YAB	
Section 9 - Exploration	YAB	
Section 10 - Drilling	YAB	
Section 11 - Sample Preparation, Analyses and Security	YAB	
Section 12 - Data Verification	YAB	
Section 13 - Mineral Processing and Metallurgical Testing	GD	
Section 14 - Mineral Resource Estimate	SI	
Section 15 - Mineral Reserve Estimate	JC	
Section 16 - Mining Methods	JC	
Section 17 - Recovery Methods	GD	
Section 18 - Project Infrastructure	JST	
Section 19 - Market Study and Contracts	JST	
Section 20 - Environmental and Social Impact	JST	
Section 21 - Capital and Operating Cost	JST	And other
Section 22 - Economic Analysis	MLB	
Section 23 - Adjacent Properties	YAB	
Section 24 - Other Relevant Data and Information	JST	
Section 25 - Interpretation and Conclusions	JST	And other
Section 26 - Recommendations	JST	And other
Section 27 - References	JST	

MLB - Michel L. Bilodeau, Eng. Independent consultant

YAB – Yves A. Buro, Eng. Met-chem

JC - Jeffrey Cassoff, Eng. Met-Chem

GD - Georgi Doundarov, Eng. Independent consultant

SI – Schadrac Ibrango, P.Geo. Met-Chem

JST - Jean-Sébastien Tremblay, Eng. Cima+

CIMA+ M03802A



2.2 Sources of Information

Information contained in this report is based on:

- “NI 43-101 Technical report on the Preliminary Economic Assessment on Lake St. Joseph Iron Property Ontario - Canada of Rockex Mining Corporation Prepared by Met-Chem Canada Inc. dated October 11, 2013;

2.3 Site Visit

The following qualified persons for this report personally inspected the Lake St Joseph Property; the dates of the visits are shown in Table 2-2.

Table 2-2 – Site Visits of the Qualified Persons

Qualified persone	Company	Date
Yves A. Buro, Eng.	Met-Chem	June 16 to 18, 2013
Jeffrey Cassoff, Eng.	Met-Chem	June 16 to 18, 2013
Jean-Sébastien Tremblay, Eng.	CIMA+	June 24, 2015

Each qualified person considers the site visit current, per Section 6.2 of NI 43-101CP, on the basis that the material work completed on the lake St Joseph Property was reviewed during the site visit, all practices and procedures documented were adhered to and no further work was carried out on the property since 2011.



3 Reliance on Other Experts

CIMA+ prepared this report using documents as noted in Section 27 “References”. Any statements and opinions expressed in this document are given in good faith and in the belief that such statements and opinions are not false and misleading at the date of this report.

Met-Chem was responsible for the resource estimate, the mine design, the environmental study and M. L. Bilodeau for the economic analysis.

This report includes technical information, which required subsequent calculations to derive subtotals, totals and weighted averages. Such calculations inherently involve a degree of rounding and consequently introduce a margin of error. Where these occur, the QPs do not consider them to be material.

The qualified persons are specialists in their respective fields and CIMA+ has no reason to doubt their conclusions and recommendations. The responsibility for the various components of the Summary, Interpretation and Conclusions and Recommendations remains with each qualified persons for their specific area of the scope.

The QPs who prepared this report relied on information provided by experts who are not QPs. The QPs believes that it is reasonable to rely on these experts, based on the assumption that the experts have the necessary education, professional designations, and relevant experience on matters relevant to the technical report.

QP M. L. Bilodeau Eng. relied upon Mr. Christopher Jacobs, CEng. MIMMM of Micon International Limited for the fiscal aspects of the economic analysis.

Cima+ relied on information supplied by Danieli for the pellet and HBI plants. Cima+ believes that it is reasonable to rely on a technology supplier that has designed, supplied and built an important part of similar plants that are currently operating globally.

For the purpose of this technical report, Met-Chem has relied mainly on information provided by Rockex Mining Corporation for the gross sales royalties.

4 Property Description and Location

4.1 Property Location

The Property is located in the Trist Lake Area, Patricia Mining Division, Sioux Lookout District, Province of Ontario, Canada. The Property encompasses Eagle, Wolf and Fish Islands and covers the southwestern part of Lake St. Joseph, (Figure 4-1)

The Property lies approximately 100 km northeast of Sioux Lookout and 80 km southwest of Pickle Lake. It is centered at approximately at 91°05'E longitude and 50°58'N latitude, on the boundary between National Topographic System (“NTS”) map sheets 52O and 52J.

4.2 Property Description and Ownership

Rockex' Lake St. Joseph Property consists of 13 contiguous mining claims covering an area of 2,592 ha (Figure 4-2). Six (6) claims underlain by granitic rocks on the south of the original Property were recently released by Rockex.

In 2006, the claims of the Property that were owned by Dofasco were allowed to lapse. Pierre Gagné staked the 23 claims in 2007 and Rockex, formerly Enviropave International Ltd., acquired them in 2008.

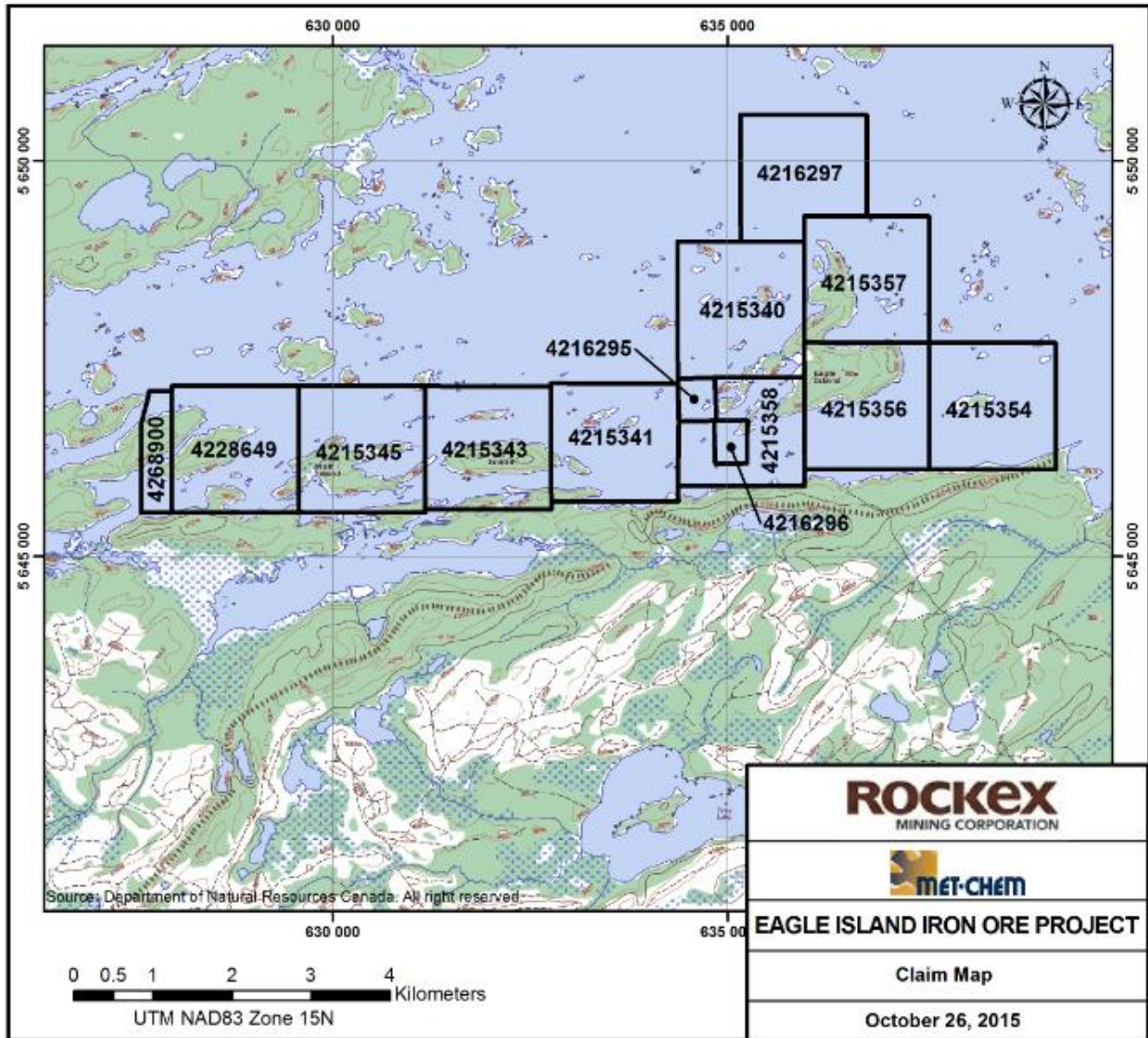
All the claims are within the Trist Lake Area, Patricia Mining Division, are active and Rockex Mining Corporation is the 100% recorded holder of the 13 claims. The Property has not been legally surveyed. Details on the claims are presented in Table 4-1.

Figure 4-1 – Site Location Map



CIMA+ M03802A

Figure 4-2 – Claim Map



CIMA+ M03802A



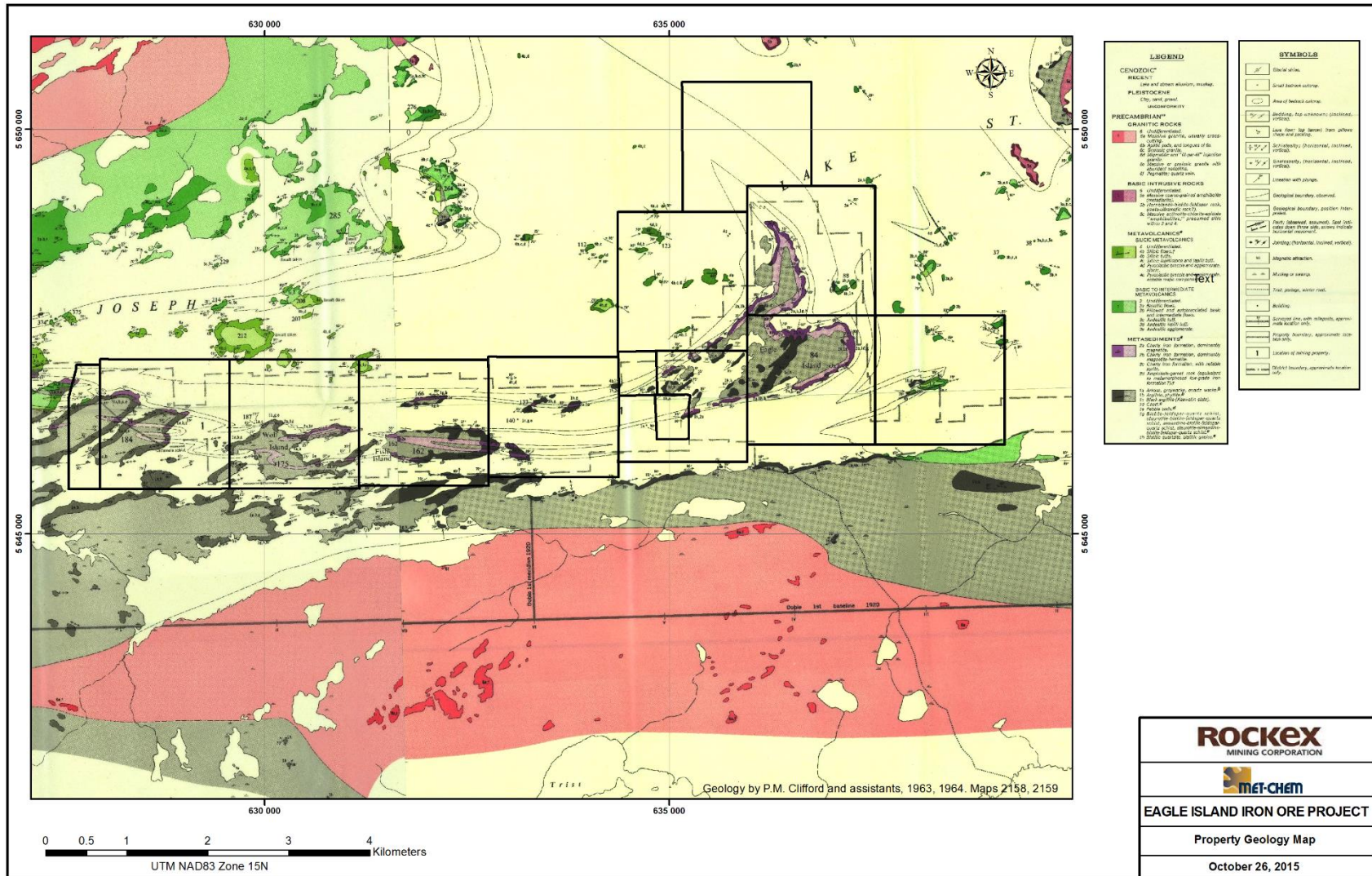
Table 4-1 – List of Claims for Rockex’ Lake St. Joseph Property

Claim Number	Recording Date	Claim Due Date	Work Required	Total Applied	Total Reserve
4215340	2007-Apr-13	2016-Apr-13	\$6,400	\$44,800	\$475,662
4215341	2007-Apr-13	2016-Apr-13	\$6,400	\$44,800	\$0
4215343	2007-Apr-13	2016-Apr-13	\$6,400	\$44,800	\$418,619
4215345	2007-Apr-13	2016-Apr-13	\$6,400	\$44,800	\$0
4215354	2007-Apr-13	2016-Apr-13	\$6,400	\$44,800	\$0
4215356	2007-Apr-13	2016-Apr-13	\$6,400	\$44,800	\$1,840,171
4215357	2007-Apr-13	2016-Apr-13	\$6,400	\$44,800	\$996,797
4215358	2007-Apr-13	2016-Apr-13	\$5,200	\$36,400	\$104,937
4216295	2008-Aug-15	2016-Aug-15	\$400	\$2,400	\$2,567
4216296	2008-Aug-15	2016-Aug-15	\$400	\$2,400	\$2,636
4216297	2010-Jul-02	2016-Jul-02	\$6,000	\$24,000	\$0
4228649	2008-Jan-28	2017-Jan-28	\$6,400	\$44,800	\$0
4268900	2012-Feb-14	2017-Feb-14	\$1,600	\$4,800	\$0

The claims include the Eagle Island Deposit, as well as additional iron formation at Wolf Island and Fish Island (Figure 4-3).



Figure 4-3 – Property Geology Map



CIMA+ M03802A



The major islands (Eagle, Fish and Wolf) contained within the Property's perimeter are covered by surface rights (Freehold Patents). Two (2) of these (PA17201 and PA17202) covering Island 184 are owned by Rockex while the others are not. A tourist operator owns the surface rights of a substantial part (but not all) of Eagle Island and another landowner owns the surface rights of part of Fish Island and Wolf Island. The coverage and extent of some of these surface patents is not completely clear. Excluded from the Property is one (1) claim (PA17195), surrounded by Rockex's holdings and is classified as a Freehold Patent located on west edge of the Property. This claim is held by Essar Steel Algoma Inc. and it includes both surface and mineral rights.

A mining claim is a square or rectangular area of open Crown land or Crown mineral rights that can range in size from 16 ha (a 1-unit claim) to 256 ha (a 16-unit claim). A claim is a mineral right that gives its holder the exclusive right to explore a designated territory for any mineral substance that is part of the public domain, except for loose surficial deposits of gravel, sand and clay. The holder of a mining claim does not have the surface rights of the claim. However, a claim owner has the right to enter, use and occupy the claim for the purpose of prospecting and the efficient exploration, development and operation of the mines, minerals and mining rights. Rockex owns the surface rights for the two (2) aforementioned patents.

To maintain a claim in good standing, approved exploration work must be completed and filed with the Ontario Ministry of Northern Development and Mines ("MNDM"). Work to a value of \$400 per year is required per claim unit, except for the first year, when no assessment work is required. Assessment work must be performed and applied to each of the mining claims until the holder applies for a Mining Lease.

On April 1, 2013, the new regulations under Ontario's Mining Act came into effect. Changes have been made as an attempt to promote mineral exploration in a manner that recognizes Aboriginal rights, is more respectful of private landowners and minimizes the impact of mineral exploration and development on the environment. Some of the changes include:

- Sites of cultural significance for Aboriginal communities may be withdrawn from claim staking;
- Exploration plans for early exploration activities are to be submitted in advance and any surface-rights owners are to be notified. Additionally, any Aboriginal groups potentially affected by the exploration activities will be notified by the MNDM and will have an opportunity to provide feedback;
- Mining companies will be required to obtain permits in advance of certain activities (i.e. drilling with equipment heavier than 150 kg). Permit applications will be subject to approval by the MNDM and will require consultation with Aboriginal groups;

- Aboriginal consultation is now required prior to the submission of a certified closure plan or amendment.

Rockex has applied for the permits that would be required in the even that additional drilling is required. Considerably more surface rights will be required for mine development and plant location and ancillary services.

4.3 Issuers Interest

The claims are currently active and Rockex is the 100% recorded holder of all 13 claims. The Property is subject to an Iron Royalty Agreement providing for a 2% royalty of the gross sale proceeds from any and all minerals mined and processed for their iron content or, starting in 2012, an annual advance royalty of \$250,000 per year (increasing at a rate of 10% per year) in the event that there is no commercial production from the Property. Pursuant to a cross-credit clause, advance royalty payments payable are credited against royalties payable from commercial production. The Property is also subject to a NSR Royalty Agreement which provides for 2% net smelter returns royalty payable on any and all other minerals produced (i.e. excluding those produced for their iron content) commencing on commercial production.

4.4 Legal Survey

The Property has not been legally surveyed.

4.5 Environmental Liabilities

No environmental studies or surveys were conducted by previous operators and there is no record of any environmental work conducted on the Property since that time. Baseline environmental studies were initiated by Rockex but a full study should be part of Rockex's next exploration program. This subject is further discussed under the chapter on Environmental Studies of this Report.

4.6 Significant Factors and Risks

Two (2) Ojibway Aboriginal communities are present in the region, relatively close to the Property:

- The Mishkeegogmang First Nation, with communities located along Highway 599 at the east end of Lake St. Joseph;
- The Slate Falls First Nation community situated approximately 40 km northwest of the Property;
- The Lac Seul First Nation;



- The Cat Lake First Nation.

Met-Chem understands Rockex management has held meetings with the representatives of the Slate Falls and the Mishkeegogamang communities. Apparently, most of the discussions centered around the conduct of exploration activities by Rockex on its claims and employment opportunities that a mining operation on the Property may generate for members of the First Nation communities.

Met-Chem is not aware of any factor that may impede development of the mineral resources on Eagle Island and/or Fish Island in the future.

Met-Chem strongly recommends that Rockex regularly engage Aboriginal communities scoped by the Crown to have an interest in the project, in addition to seeking input from local stakeholders to foster a good relationship.

Most of the information in this Section is drawn from various communications with Rockex and from descriptions in WGM's report (2011). Additional information on Aboriginal engagement can be found in WGM's technical report.

Met-Chem is not aware of other significant factors, or risks that may affect access, title or the right or ability to perform work on the Property.

5 Accessibility, Climate, Local Resources, Infrastructure and Physiography

5.1 Access

The Property is currently accessed via a logging road, the Vermilion River Road, that exits Highway 516, about 30 km northeast of Sioux Lookout (Figure 4-1). This road continues northwards and branches to the northwest and to the northeast at 75 km from its junction with Highway 516. The northeast branch follows an esker to the south shore of Lake St. Joseph. Rockex's camp is located 100 m south the shoreline of Lake St. Joseph opposite Eagle Island. The drive from Sioux Lookout to the camp takes approximately 2.5 hours.

The road is apparently a public road from its junction with Highway 516 to km 75 and from there to the camp it is a logging road maintained under permits granted to Buchanan Forest Products ("Buchanan") and parent company McKenzie. The road crosses several creeks and the Ministry may require the forestry company to remove the culverts when its operations in the area are complete. Apparently, Rockex has a verbal understanding with Buchanan to use the road.

The Property Eagle, Wolf and Fish Islands are also accessible by boat from the east end of the Lake, via Highway 599, which connects Pickle Lake to the Trans-Canada Highway at Ignace and reaches the east end of Lake St. Joseph, approximately 40 km east of the Property.

5.2 Climate

The closest weather station is located at Kenora. The Kenora area has a humid continental climate with warm summers and cold, dry winters. Mean daily summer temperatures at Pickle Lake range from 14 to 18°C, with the daily maximum average in July reaching 24°C. In January and February, mean daily temperatures are approximately -21 to -17°C. Mean annual precipitation is about 720 mm, including about 260 cm of snowfall (Table 5-1).

Although winter days can be cold and snow accumulation significant, Canadian miners are experienced at operating mines under even harsher climatic conditions than the ones prevailing in the Project area.

Table 5-1 – Kenora Average Weather by Month

Month	Temperature (°C)		Average Precipitation (mm)		Average Snow Days
	Miximum	Minimum	Daily	Monthly	
January	9.1	-37.3	0.9	27	20
February	8.8	-41.4	0.7	18.5	17
March	16.6	-34	0.9	26.9	15
April	27.4	-21	1.4	41.9	8
May	30.2	-8.9	3	91.5	3
June	35.6	1.1	4.1	123.1	0
July	34	4.8	3.4	106.6	0
August	34	3.9	2.9	89.6	0
September	31.4	-2.2	3.2	95.3	1
October	25.6	-12.7	2.1	63.6	8
November	17	-25	1.4	41.7	19
December	6.3	-37.3	1	30.8	22

(Source: <http://www.meoweather.com/>)

5.3 Local Resources and Infrastructures

Pickle Lake is the closest town to the Property and it is located on Highway 599, approximately 40 km north of where the highway reaches Lake St. Joseph. The town has a nominal population of 479 that fluctuates widely on a seasonal basis. Pickle Lake was developed in the 1930s as the town site for the Pickle Crow and Central Patricia gold mines. Both these former mine sites are now part of the Township of Pickle Lake.

The Central Patricia gold mine was closed in 1951 but supported a population of 400 during its life. Production at Pickle Crow ceased in 1966, bringing to an end the boom which had started in 1935. Pickle Lake boomed once again in 1974, with the construction of Union Minière Explorations (“UMEX”) and Mining Corporation’s Thierry copper-nickel mine located 10 km northwest of Pickle Lake, in production between 1976 and 1982. The population, which reached a peak of 1,200 in 1981, dropped once again to around 400. In 1987, after years of exploration activities, the community once again became a boomtown.

Both Placer Dome Inc. (“Placer Dome”) and St. Joe Canada (“Bond Gold”) opened mines in the Pickle Lake area. Placer Dome constructed Dona Lake mine, 35 km northeast of Pickle Lake that was active between 1987 and 1993. The Bond Gold mine was 48 km northwest of Pickle Lake and closed in 1995. In 1996, Placer Dome opened the Musselwhite mine approximately 160 km north of Pickle Lake.

CIMA+ M03802A



The municipality of Sioux Lookout, which includes the town of Hudson, is located approximately 100 km southwest of the Property and 80 km by road, north of the Trans-Canada Highway. Located on the Canadian National Railway, it has a population of approximately 5,500 persons. McKenzie has a saw mill in Hudson that employs about 350 people.

Road access to the Property is currently provided via a gravel road that has partial year-round access, extending north from Provincial Highway 516. The gravel road is used primarily for timber cutting and haulage north of Sioux Lookout, and is capable of handling standard road tractor-trailer combinations.

The Sioux Lookout municipal airport services scheduled and charter flights with connecting flights to over 40 destinations in Canada and the USA.

The concentrator will be located on the south shore of Lake St. Joseph. The pellet plant and the hot briquetted iron plant and train load-out will be on a complex located east of Sioux-Lookout. The CN Rail mainline network is located in the centre of the town of Sioux-Lookout. The CP railway passes about 70 km south of Sioux-Lookout.

Natural gas is currently routed via the TransCanada Pipeline, which roughly follows Highway 17 in this area through Ignace, Dryden and Kenora. The closest point of contact would be approximately 100 km away, necessitating the construction of a pipeline through Sioux Lookout, and up to the site.

The nearest hydro-electric power to the Property is located at Slate Falls fed by a 115 kV transmission line. There are plans to upgrade this to a 230 kV line in the midterm (10 years). Currently this line is probably insufficient to support a substantial iron mine. For its planned operations at the east end of Lake St. Joseph, Steep Rock applied for a permit to survey a route for a power line from Raleigh (just north of Ignace on Highway 17) to its property.

The alternative of connecting to the new 230 kV power line of the Wataynikaneyap project planned for 2015 could be examined at the next phase.

The area on Eagle Island is not large enough to accommodate all of the potential processing plant, tailings storage and waste disposal sites, an area on the mainland south of Eagle Island has to be set aside for the required infrastructure.



5.4 Physiography

Lake St. Joseph is 374 m above sea level (“ASL”) and maximum elevation on Eagle Island is approximately 400 m ASL. Fish and Wolf Islands have slightly less topographic relief, like the area south of Lake St. Joseph, ranging to about 410 m ASL. Physiography is controlled mainly by thick accumulations of glacio-fluvial deposits.

During the site visit, Met-Chem noticed a general relationship between the topographic high ground on the Eagle Island and the presence of the more erosion-resistant iron formation outcrops.

The natural drainage for Lake St. Joseph was east by the Albany River into James Bay, but dams at the east end of the lake and openings bulldozed at the west end of the lake, have resulted in the diversion of water into the English River watershed to feed reservoirs supplying hydro-electric generating stations. Water flows out at the southwest end of Lake St. Joseph into the Roots River and enters the northeast end of Lac Seul. Lac Seul, which is drained by the English River, provides water for hydro-electric stations at Ear Falls (townsite for the former Griffith iron mine), where the English River leaves the lake, and Manitou Falls, 30 km downstream, to generate 90,600 kW of electricity.

The Property is mainly covered by spruce boreal forest.

5.5 Fauna

Black bear, moose, lynx, cougar, white-tailed deer, red fox, short-tailed weasel, mink and river otter are present in the Property area. Bird species include bald eagle, blue heron, belted kingfisher, common nighthawk, grey jay, common loon, and various waterfowl.

6 History

6.1 Prior Ownership

Several companies owned the St. Joseph Lake Property until the claims were allowed to lapse (Table 6.1). Eventually, the Property claims were staked by P. Gagné and were acquired by Rockex in 2008.

6.2 Significant Historical Exploration Activities

The main activities directly related to the mineral exploration and development of the Property is summarized in Table 6.1.

Additional information is provided by WGM's 2011 technical report.

Table 6-1 – Summary of Mineral Exploration and Development on the Lake St. Joseph Property

Company	Date	Mineral Exploration & Development Work
Ontario Bureau of Mines	c. 1900	<ul style="list-style-type: none"> • Exploration • Jabez Williams staked claims over the Lake St. Joseph iron deposits • Drilling (Fish Island)
Ontario Department of Mines	1921	<ul style="list-style-type: none"> • Report on Iron Formation of Lake St. Joseph
Cons. Mining & Smelting Company of Canada Ltd.	1931-1932	<ul style="list-style-type: none"> • Trenching • Drilling, 5 holes
Antiquois Mining Corp. (St. Lawrence Columbiun & Metals Corp.)	1956	<ul style="list-style-type: none"> • Geological and geophysical surveys (dip needle magnetometer) • Trenching
Lake St. Joseph Iron Ltd. ("LSJI"), (St. Lawrence Columbiun & Metals Corp.); Holannah Mines Ltd.; M.A. Hanna Co.	1957	<ul style="list-style-type: none"> • Bulk sampling (Eagle Island) • Trenching • Dip needle survey • Metallurgical test work
	1957-1959	<ul style="list-style-type: none"> • Diamond drilling, 14,668 ft (4,471 m) in 35 holes "Reserve" estimate

CIMA+ M03802A



Company	Date	Mineral Exploration & Development Work
Algoma Steel Corp. Ltd. ("Algoma")	1966-1967	<ul style="list-style-type: none"> Option on the Gustafson property (SE of Eagle Island) Ground magnetic survey Drilling, 6 AXT-sized holes for 3,367 ft (1,315 m) Property acquisition
	1968-1969	<ul style="list-style-type: none"> Option of LSJI's property (Eagle, Fish and Wolf Islands) Mapping; magnetic & gravity surveys Trench re-sampling Basic mineralogical studies and test work
	1973	<ul style="list-style-type: none"> Leasing 73 claims from LSJI Bulk sampling, 1,100 tons (Eagle Island) Metallurgical tests (pilot)
	1974-1975	<ul style="list-style-type: none"> Diamond drilling, 71 holes, 46,516.0 ft (14,178.25 m) Davis Tube tests on composite samples, SolFe analyses of the head, concentrates and tails Ground magnetic survey
	1975	<ul style="list-style-type: none"> Pilot plant tests, flow sheet development Geophysical surveys Re-opening old trenches
Algoma, Stelco and Dofasco	1976	<ul style="list-style-type: none"> Eagle Island iron property selected as best in NW Ontario for development
Algoma	1978	<ul style="list-style-type: none"> Diamond drilling, 3 holes for 1,404.80 ft (428.20 m), 2 on Fish Island
	1979	<ul style="list-style-type: none"> Acquisition of 70% of LSJI shares Studies on the development potential of the property Geological mapping (Fish Island; 1979-82)
Dofasco	1988	<ul style="list-style-type: none"> Acquisition of Algoma (and LSJI)
	2006	<ul style="list-style-type: none"> Claims became open
Pierre Gagné	2007	<ul style="list-style-type: none"> Staking of the Property
Pierre Gagné; Rockex	2008	<ul style="list-style-type: none"> Additional claims staked or dropped Drilling 5 confirmation twin holes for 1,312 m Searching for historical hole collars WGM : Technical Report on the LSJI Project for Rockex (May 2008) Characterization of 4 core samples (SGS Mineral Services – Lakefield ("SGS"))

CIMA+ M03802A



Company	Date	Mineral Exploration & Development Work
Rockex	2009-2010	<ul style="list-style-type: none"> Acquisition of historic Algoma data files and core from Essar
	2010	<ul style="list-style-type: none"> Additional claims staked WGM: Updated Technical Report on the Western LSJI Project (Sept.)
	2011	<ul style="list-style-type: none"> WGM: Technical Report & Mineral Resource Estimate On The Western LSJI Project (Jan.) Airborne geophysical survey Metallurgical testing
	2011-2012	<ul style="list-style-type: none"> Diamond drilling, 16 holes for 7,937.10 m

6.3 Historical Resources

6.3.1 Pre-NI 43-101 Resource Estimates

Prior to the latest estimate by WGM in 2011, resource for the Property had been estimated in 1956-1957, 1961 and 1975. WGM examined some of the old data, commented on these historical resource estimates in their 2011 report. Met-Chem will not quote or comment on the historical resource or reserve figures of 1957 or 1961, since they are non-compliant with the requirements of NI 43-101, are outdated and irrelevant for the purpose of this Report. Indeed, details on the analytical methods, or parameters and methodology used are lacking or may have changed so much as to not realistically reflect the present conditions.

The most recent historical mineral resource estimate that Met-Chem is aware of for the area west of Eagle Island was completed by Algoma in 1975. The results from this historical estimate are presented by WGM (2011) and were drawn from a report prepared by Algoma and dated November 26, 1975. These estimates were completed prior to the implementation of NI 43-101 and should not be relied upon. The main parameters and methodology applied to the estimate, such as the assay method, mass units (long or short tons), depth of the ultimate pit, etc., are unknown. These historical estimates are only discussed in the present Report because they might become relevant since the iron mineralization west of Eagle Island may, in the future, be considered as potential feed to the concentrator that would process the mineralization from Eagle Island, and possibly use some of the infrastructure and facilities built for Eagle Island.

CIMA+ M03802A



Algoma estimated a tonnage and grade of iron mineralization for the Fish Island area contained in an open pit. Fish Island is located about 2.5 km west of Eagle Island. The estimate is based on the results from geophysical surveys, surface trenches and 14 LSJI holes drilled in 1957 to 1959 and aggregating about 7,000 ft (2,135 m). The tonnage and grade for iron mineralization extending to the west of Eagle Island, labelled as the West Extension Area and the North Limb, were also estimated (Table 6-2). The calculations are based on data from drill holes at approximately 500 m (1,600 ft) intervals, since this zone is entirely under water of Lake St. Joseph.

Table 6-2 – Historical Estimate of Iron Mineralization in the Fish Island and West Extension Areas (After Algoma, 1975).

Zone	Tonnage (M Long tons)	Grade (%Fe)
Fish Island	203	35.8
West Extension	55	23.4
Total	258	33.2

However, WGM (2011) quoted a memorandum by J.V. Huddart of Algoma, suggesting that, on the basis of 1981 mapping results, the Algoma estimates for Fish Island were overly optimistic and stated that the potential of the Wolf Island-Fish Island area is in the order of 100 M long tons rather than the 250 Mt. No documentation is available to Met-Chem in order to comment on this statement.

Although Met-Chem has not verified the historical resource estimate, on examination of the maps and drill results for the Fish Island area, the tonnage estimated by Algoma appears to be reasonable. In addition, two (2) holes drilled in 1978 and two (2) holes drilled in 2011 confirmed the presence of significant width and grade of iron mineralization at Fish Island. The iron formation has been traced westward from Eagle Island by geophysical survey, mapping and drilling over a distance of about seven (7) km.

The classification of the mineralization by Algoma is not compliant with the resources and reserves definition of Council of the Canadian Institute of Mining, Metallurgy and Petroleum (“CIM”) (November 2010). No attempt has been made by a Met-Chem’s QP to classify the historical estimates as current mineral resources or mineral reserves, and Rockex is not treating the historical estimate as current mineral resources or mineral

CIMA+ M03802A



reserves. Additional drilling is required to verify or upgrade the historical estimate for the area west of Eagle Island as current mineral resources or mineral reserves.

6.3.2 NI 43-101 Compliant Resource Estimates by WGM

WGM prepared a Mineral Resource estimate for the portion of the Lake St. Joseph Iron Project that had sufficient data to allow for definition of continuity of geology and grades. Consequently, WGM modeled the main Eagle Island mineralization, but did not include the Fish Island or Wolf Island areas.

WGM only used 63 Algoma holes totaling 20,829.95 m in their resource estimate. The estimate was completed using a block modeling method and the grades were interpolated using the Inverse Distance estimation technique.

Indicated Mineral Resources were defined as blocks being within 100 m of a drill hole intercept and Inferred Mineral Resources were interpolated out to a maximum of about 350 m on the edges of the deposit and at depth. A summary of the WGM's Mineral Resources is provided in Table 6.3.

Table 6.3 – Mineral Resources Estimate by WGM (2011)*, Eagle Island Deposit

Resource Classification	Tonnes (000s)	% SolFe Head – Individual Samples	% SolFe Head - Composite	% MagFe Head – Composite	% HmFe Head – Composite
Indicated	590,847	28.84	28.43	14.86	13.56
Inferred	415,757	29.47	29.07	14.52	14.55

* (Cut-off of 18% Head SolFe)

WGM assured that the classification of the Mineral Resources conformed to the definitions provided in NI 43-101. WGM further confirmed that they had followed the guidelines adopted by the CIM Standards in arriving at their classification. The details on the methodology and calculations performed by WGM are provided in their 2011 technical report.

Met-Chem has not verified the details of the methodology and calculations and has not validated the work completed by WGM. No attempt has been made by a Met-Chem's QP to classify the WGM's estimate as current mineral resource, and the resource figures are only quoted for comparison purposes with the present resource estimate by Met-Chem.

CIMA+ M03802A



However, Met-Chem has every reason to believe that the resource estimate done by WGM reflects WGM's abundant experience in modeling the type of mineralization similar to the Lake St. Joseph iron deposit. Regardless, the present resource estimate by Met-Chem relies on drill hole data not available to WGM; consequently the resources estimate by WGM can no longer be considered as current and is superseded by the present estimate.

In order to estimate the resources that are the subject of this Report, Met-Chem used the 3D model constructed by WGM and modified by Rockex. Met-Chem augmented the database and the model with the results from the drill holes completed in 2008 and 2011-2012, updated the geological interpretation accordingly and made a few adjustments as seen fit. Details on the methodology and parameters applied to the resource estimate by Met-Chem are provided under Section Mineral Resource Estimate of the present Report.

6.4 Production

No production of iron mineralization has been reported from the Lake St. Joseph Property.

7 Geological Setting and Mineralization

7.1 Regional Geology

The Property is situated in the Lake St. Joseph Archean greenstone belt of the Uchi Subprovince of the Canadian Shield. Younger and older felsic and mafic plutons underlie, surround and intrude the greenstone belt. The Lake St. Joseph greenstone belt is composed of four (4) volcanic cycles and each contains a sequence of basal tholeiitic basalt flows progressing upwards into dacitic to rhyolitic pyroclastic rocks. In the Lake St. Joseph area, the Cycle 2 volcanic rocks are unconformably overlain by a suite of clastic and chemical sedimentary rocks that form the Eagle Island assemblage, or Upper Clastic Rocks, which hosts the iron formation on the Property.

The base of the Eagle Island assemblage consists of eroded dacitic pyroclastic material derived from the upper part of the Cycle 2 volcanics. This sequence is succeeded upwards by arenite and wacke-sandstone beds, interbeds of mudstone, conglomerate and banded iron formation. The banded iron formation of Lake St. Joseph extends for an east-west strike length of approximately 10.5 km.

Shearing parallel to bedding is extensive adjacent to the regional Sydney Lake – Lake St. Joseph Fault passing along the south shore of the portion of Lake St. Joseph. Metamorphism is typically greenschist facies in the Lake St. Joseph area.

7.2 Property Geology

7.2.1 General

The Property is underlain by mafic to felsic volcanic rocks of Cycles 1, 2 and possibly 3, or by the Eagle Island sedimentary assemblage. The Eagle Island assemblage consists mainly of greywacke, shale, conglomerate and iron formation (Figure 4-3 and Table 7-1) deposited unconformably in a basin along the southern margin of the volcanic belt and subsequently re-folded with the volcanic sequence.

The sedimentary assemblage is largely in the form of an east-west trending, steeply plunging syncline containing a pair of sub-parallel anticlinal folds most clearly evident on Eagle Island. The south limb of the syncline, traceable because of its contained magnetic iron formation, extends from Eagle through Fish and



Wolf islands and further west. The north limb of the syncline has been traced by magnetic surveys and a few drill hole intersections as extending west from Eagle Island and north of Fish Island.

The folded iron formation on the north part of Eagle Island is about 350 m to over 400 m wide and has been traced over a distance of approximately 1.3 km and to vertical depths of up to 500 m. The south east extension of this north part of the iron formation extends to form the east and south limits of the south shore of Eagle Island. The iron formation in this domain has a strike length in the order of 2 km, a true thickness varying from approximately 80 m to 200 m, with thicknesses diminishing with increasing distance along strike away from the north part of Eagle Island.

Multiple bands of iron formation exposed on Fish Island, 2.5 km west of Eagle Island, may be due to second-order folds along the south limb of the main structure or may represent a repeated sequence at the nose of another isoclinal fold. A series of trenches and drill holes have tested the sub-vertical zone over a strike length of 1.3 km to vertical depths of about 400 m.

Minor dykes were encountered but no major intrusive rock cutting into the iron formation sequence has been mapped.



Table 7-1 – Regional Stratigraphy Column (after Stott, 1996)

PHANEROZOIC
CENOZOIC
QUATERNARY
RECENT
Lake, stream and wetland deposits
PLEISTOCENE
Till, glaciofluvial sand and gravel, glaciolacustrine sand and clay
<i>Unconformity</i>
PRECAMBRIAN
PROTEROZOIC
PALEOPROTEROZOIC
Mafic Dikes
Diabase dikes
ARCHEAN
MESOARCHEAN to NEOARCHEAN
Felsic Intrusive Rocks
Unmetamorphosed late to post tectonic granitic rocks
Granodiorite, monzogranite, syenogranite, syenite, tonalite, trondhjemite, quartz diorite, granite pegmatite
<i>intrusive contact</i>
Metamorphosed pre- to syntectonic granitic rocks
Granodiorite, tonalite, trondhjemite, monzogranite, syenogranite, quartz diorite, granite pegmatite
<i>intrusive contact</i>
Metamorphosed felsic porphyry intrusive rocks
Quartz porphyry, feldspar porphyry, quartz-feldspar porphyry, felsite
<i>intrusive contact</i>
Mafic to Ultramafic Intrusive Rocks
Metamorphosed mafic intrusive rocks
Gabbro, diorite, anorthosite, melanocratic gabbro, leucocratic gabbro, plagioclase feldspar - phyrlic mafic intrusive rock, quartz-bearing mafic intrusive rock, peridotite, pegmatite
<i>intrusive contact</i>
Metavolcanics and Metasediments
Clastic metasediments
Lithic wacke, quartzose wacke, feldspathic wacke, mudstone
Chemical metasediments
Oxide facies (magnetite-bearing), sulphide facies (pyrite-bearing), silicate facies (amphibole-rich), and carbonate facies (siderite/ankerite) iron formation
Felsic metavolcanics
Massive flows, tuff, lapilli tuff, lapillistone, quartz-feldspar porphyry
Intermediate metavolcanics
Massive flows, pillowed flows, tuff, crystal tuff, lithic tuff, lapilli tuff, lapillistone, tuff breccia, pyroclastic breccia, quartz-feldspar porphyry
Mafic metavolcanics
Massive flows, pillowed flows, pillowed breccia, amygdaloidal flows, variolitic flows, autoclastic flow breccia, tuff, crystal tuff, lapilli tuff, lapillistone, tuff breccia, pyroclastic breccia, ultramafic tuff, amphibolite, epidote-rich layered flows or pyroclastic rock

CIMA+ M03802A



7.2.2 Structure

The Lake St. Joseph iron formation is essentially in the form of an east to northeast trending, upright, steeply plunging syncline with superimposed coaxial anticlines. Isoclinal, second-order folds are common. The steeply dipping, tight and isoclinal folds have resulted in repeats in the iron formation sequence which is mainly coincident with the north, east and south shores of Eagle Island. Because of the folds, the bulk of the iron formation on the Property is concentrated on, and adjacent to, Eagle Island.

7.2.3 Mineralization

The iron formation consists of units of fine-grained iron oxide and silica interlayered with beds of greywacke, shale, mudstone, phyllite and conglomerate. Some layers also contain minor pyrite or pyrrhotite, but sulphide content of the oxide iron formation is generally sparse. Graphitic meta-sedimentary layers containing increased amounts of pyrite have been identified southeast of Eagle Island. The distribution of sulphide components may be partly controlled by stratigraphy (graphitic horizons) but also by gold-related alteration systems that affect various parts of the iron formation sequence, but apparently not to any significant extent the current Mineral Resource area.

Mineralization consists of fine-grained, near massive and intimate mixture of specular hematite and magnetite or well-banded magnetite containing very little hematite component alternating with quartz-chert beds. Gangue consists of silica, sericite, biotite, chlorite, carbonate with some hornblende and apatite. The ratio of hematite to magnetite in the iron formation on the Property has been variously reported as 3:1 to 1:1. Met-Chem agrees with WGM that variations in the hematite or magnetite abundance may occur in different parts of the Property.

From the calculated proportion of iron locked magnetite and in hematite, WGM found that the 2008 assay results indicated the pattern of dominantly hematitic mineralization with minimal magnetite. Met-Chem believes the variation in the distribution of the magnetite-ratio within the deposit is yet undetermined.

Metallurgical and mineralogical work conducted in the mid-1970s suggests that the grind requirement for liberation is 85% passing 500 mesh.

In 2008, SGS completed an Investigation into the Mineralogical Characteristics of Four Samples of Iron Formation, petrographic microscopy, X-ray Diffraction, QEMSCAN and electron micro-probe analysis. The



work showed that the samples contained iron oxides and quartz as the main mineral species, followed by subordinate, but significant, amounts of micas and feldspar minerals.

The aluminum, potassium, sodium and phosphorus levels are a little higher than in typical Algoma oxide iron formation. This may be due to the higher content of sediments in the Lake St. Joseph iron formation compared to a typical Algoma iron formation. However, the deleterious element levels in the head analyses are not necessarily proportional to concentrations in iron concentrates.

During the site visit, Met-Chem observed a locally significant number of quartz veins crossing the iron formation, with evidence of multi-phase injection. Met-Chem also observed red jasper beds in several outcrops but was unable to determine whether they could serve as a marker horizon.



8 Deposit Types

The Lake St. Joseph mineralization is considered to be iron formation of the Algoma-type, but it does have some characteristics that are not typical of Algoma iron formation.

Meyn and Palonen (1980) interpreted the Lake St. Joseph iron formation assemblage to be the product of a submarine fan environment. Unlike typical Algoma-type iron formation, the assemblage is turbiditic containing greywacke, shale, siltstone and conglomerate.

Typical Algoma-type iron formation consists of alternating beds of micro- to macro-banded iron oxides (magnetite and hematite) and quartz (chert), with variable proportions of oxide, carbonate, silicate and sulphide lithofacies. The deposits are interbedded with volcanic and sedimentary rocks formed near or distal from extrusive centres such as volcanic arcs or spreading ridges.

Such iron formations are the second most important source of iron after Lake Superior-type iron formations (Gross, 1996). However, no Algoma-type iron formation is currently mined in Ontario for iron. The Sherman, Adams and Griffiths mines that previously operated in Ontario mined similar iron deposits. The salient characteristics of the Algoma-type iron deposit model, as described by Eckstrand, (1984), can be found in WGM's 2011 report.

The Lake St. Joseph iron formation has been affected by several episodes of tight to isoclinal folding, which is an important factor to take into account when planning any exploration program.

9 Exploration

9.1 Historical Exploration

LSJI's initial exploration programs on the Property began in 1957 and continued through 1961. The programs consisted of extensive drilling and trenching covering Eagle, Fish and Wolf Islands. Dip Needle magnetic surveys were also conducted covering a large percentage of the Property.

From 1966 to 1981, Algoma carried out work on the Property that consisted of re-sampling of selected LSJI trenches and drilling two (2) Winkie holes, in order to validate the results reported by LSJI. Geological mapping and extensive Fluxgate ground magnetometer and gravity surveying were also carried out. Six (6) core holes were drilled as well.

Metallurgical work was completed in 1974-1975 at the at the Ontario Research Foundation ("ORF") facility west of Toronto. Initial work included microscopic examination that revealed iron minerals are mainly hematite and magnetite, in an overall ratio of 1:1, within a gangue of quartz, sericite, mica, carbonate, with some hornblende and apatite. It was concluded that grind requirements were 85% passing 500 mesh. The final report completed by the ORF on a pilot plant test work has not been recovered, but a detailed summary of the results is available in a memorandum from the Hanna Mining Co. dated October 20, 1976.

In addition to the work conducted by Algoma and Hanna, routine Davis Tube ("DT") testing of the drill core samples from Algoma's drill campaigns was also completed. Results are available for the 1974 and 1975 Algoma drill hole composites.

After the foregoing, little recorded exploration work was carried out on the Property until 2008.

9.2 Rockex Exploration

Rockex's first exploration program on the Property was initiated in March 2008. It consisted largely of a limited-scope drilling of twin core holes to validate historic Eagle Island drill results. Later in 2008, Rockex completed field mapping and searched for historic drill hole collars and trenches on Eagle Island.

In 2008, SGS carried out a study of the mineralogical characteristics and iron deportment on four (4) samples to develop the optimum process flow sheet for the deposit. Subsequent to this work, SGS carried out a review of four (4) previous reports on the metallurgical work on the Eagle Island deposit.

In April 2007, Essar Steel Holdings Ltd. (“Essar”) purchased Algoma Steel. In late 2009, Essar transferred to Rockex the archived drill core from Algoma’s 1974-1975 and 1978 campaigns in the original core boxes. The drill logs and assays results, reports and maps not available in the public domain were also delivered to Rockex. In early 2010, Rockex undertook a program of re-sampling and assaying of three (3) of the Eagle Island drill holes acquired from Essar, in order to validate the historic logging and assay results.

The main results from Rockex’ exploration work was the validation of the analytical results from all the core drilled in 1974-1978 that could be incorporated onto the master database and be used in the resource estimate. This information, combined with two (2) drilling programs and preliminary metallurgical testing was sufficient to define NI 43-101 compliant resource estimate in a large part of the Property.



10 Drilling

10.1 Historic Drilling

Drilling campaigns are reported to have been conducted to test the iron formation prior to 1920, in 1931-1932, 1957-1959 and 1966-1967. Although significant records are available for the programs conducted by LSJI in the 1950s and by Algoma in the 1960s, the results are not discussed here, although they were described in WGM's report because of their historic interest.

The present resource estimate by Met-Chem is based on validated drill hole data only and includes the results from the drilling programs of 1974-1978 onward, except for the twin holes drilled in 2008, for reasons explained under Mineral Resource Estimates of the present Report.

10.2 Algoma Drilling

Algoma completed an extensive drilling program in 1974-1975, mostly on, and adjacent to, Eagle Island. Five (5) holes tested the north limb of the main structure northeast of Fish Island and two (2) drill holes were completed northwest of Wolf Island. Another two (2) holes were drilled on Fish Island in 1978. The aggregate footage for the 1970s programs sums to 14,606 m in 74 drill holes. The core, assay results and logs from the holes drilled by Algoma in 1974-1978 became available to Rockex and could be validated by re-logging and re-sampling to be incorporated into the database with the more recent data generated by the holes drilled by Rockex.

Sampling by Algoma was in nominal 10-foot core lengths similar to the sampling done by LSJI. No descriptions are available for the drill core sampling procedure, but from examination of Algoma's archived drill core, WGM found that drill core had been split and one half was retained in the core trays, the other one was sent for assaying. No sample tags are contained in the trays and markings on the core or trays are generally lacking.

Details on the drilling activities are presented in the WGM's 2011 technical report.

10.3 Rockex 2008 Drill Program

Rockex’s initial drill program started in March 2008 with a program of five (5) twin holes aggregating 1,312 m. Table 10.1 lists the pairs of original and twinned holes, and distances between them.

Originally, drill hole EI-103 was spotted to twin the historic hole J-23-59 from Lake St. Joseph Iron Mines Ltd. The distance between the two (2) appears to be 15 m. The purpose of the program was to validate historic results. Four (4) of the drill holes selected for twinning had been drilled by Algoma in 1974. Rockex drill hole EI-104 was abandoned early at 203.3 m depth due to lost water circulation.

Table 10-1 – Original and Twin Holes Drilled by Rockex in 2008

Twin Hole (2008)	Original Drill Hole (1974)	Distance (m)
EI-101	EI74-005	35
EI-102	EI74-004	52
EI-103	EI74-023	55
EI-104	EI74-009	29
EI-105	EI74-010	16

All drill hole locations were spotted and re-checked on the casings after drilling using a precision GPS Trimble GEOXH to obtain UTM co-ordinates (NAD 83, Zone 17) with half-metre precision. Azimuths were set by sighting foresights using a GPS and the collar dips with an inclinometer. Acid dip tests were taken down the hole at 100-ft spacing, except in EI-104. Relatively severe flattening of the plunge of the hole, in the order of 20° between the collar and the bottom of the hole, was indicated.

Discovery Diamond Drilling Ltd., Morinville, Alberta, was contracted by Rockex to complete the 2008 program. NQ size core (47.6 mm) was retrieved.

Jean-Paul Barrette, Geo., was the Senior Geologist in charge of the program, as well as the designated Qualified Person in compliance with NI 43-101. A report entitled “*Drill Report, Western Lake ST. Joseph Iron Ore Project 2009, Trist Lake Area, Kenora Mines & Minerals Division, Ontario, NTS 52J/14NE, for Rockex Limited, 580 New Vickers St., Thunder bay, Ontario. P7E 6P1, By Jean-Paul Barrette Geo, Senior Geologist, and by Mitch Dumoulin, P. Geo., Senior Geologist; March 12, 2009; Thunder Bay, Ontario*” describes the drilling program.

CIMA+ M03802A



J. P. Barrette completed detailed core logging, using a formatted Excel spreadsheet. Sampling was done systematically on 10-foot core lengths, with a few exceptions for the dykes. These lengths were chosen to correspond to the geological units and mineralized zones in the five (5) historic drill holes that Rockex duplicated, to allow comparisons of the results. The procedure included a QA-QC program of Blank, Duplicate and Replicate samples. Felsic dykes or sediments were commonly used as blanks.

Missing in the logs description is the core recovery percentage, but was reported as averaging 99.9% for each drill hole (Drill Report, 2009). Photographic record of the core was taken as well as magnetic susceptibility measurements, usually on the split core. Bulk density determinations were performed on a few core samples, using the water immersion method, as well as on about 16% of the pulp samples, by pycnometer.

10.4 Rockex 2011-2012 Drill Program

A drill program consisting of 7,937.1 m in 16 holes was completed between September 24, 2011 and January 27, 2012. Of these, 14 were drilled for a total of 6,917.9 m on or around Eagle Island, and two (2) of them were drilled on Fish Island for 1,019.2 m.

The main purposes of the program was to further test the junction area between the north part of the iron formation with SE extension, on Eagle Island, as well as completing a few infill holes and drilling along the extension of the iron formation at depth and laterally.

Rockex contracted Full Force Diamond Drilling Ltd. of Peachland, British Columbia, to perform diamond drilling using two (2) Zinex A5 rigs equipped to retrieve NQ2 size core (50.6 mm). The casing was left in all the holes and was capped with a wooden plug and identified with an aluminum tag stapled to a picket.

Cygnus Consulting Inc. ("Cygnus"), Montreal, Quebec, supervised the drilling program, carried out core logging and sampling and bagged the samples for shipment to the laboratory. The work was done under the supervision of David H. Albert, P. Geo. Cygnus prepared a report entitled: *"Assessment Work Report, Diamond Drilling Campaign on the Western Lake St. Joseph Property (2011), NTS 52J/14, for Rockex Mining Corporation, Submitted to the Northern Development and mines of Ontario; Prepared by David H. Albert, P. Geo, Associate Geologist; June 22, 2012; Cygnus Consulting Inc."*



Although Cygnus logged the main lithological contacts, the samples were largely based on systematic lengths of 3 m, without regard for the lithological contacts. Cygnus inserted blank samples into the sample sequence as the only form of monitoring the laboratory performance. No photographic record of the core, percent core recovery, magnetic susceptibility measurements or RQD calculations have been found by Met-Chem in the drill logs or in Cygnus report.

The hole path deviation was surveyed using a Deviflex instrument that is not affected by magnetic rocks, since it does not rely on a magnetic compass to measure the deviation along the azimuth.



11 Sample Preparation, Analysis and Security

11.1 Sample Preparation and Analyses

LSJI plotted the analytical results on cross-sections as % Fe, without providing details on the assay methods, whether Soluble Iron or Total Iron, or on the laboratory. However, this data were not incorporated into the present resource estimate, as Met-Chem considers it is of historical interest only. Additional information on the subject is provided in WGM's 2011 report.

11.2 Algoma Drill Program (1974-1975)

Correspondence and a sample preparation flow sheet examined by WGM indicate that the drill core samples had been prepared and analysed at SGS. Details of the iron assays for individual samples and DT composites are not known with certainty, but likely included acid digestion followed by titration of soluble Fe.

The Rockex database contains 3,534 SolFe assays for the 1974-75 drill holes and 129 for the two (2) holes drilled in 1978 on Eagle Island. In addition, 503 DT tests results from Algoma's 1974-1975 and 29 from the 1978 drill holes were performed at SGS on samples that were mostly ranging from three (3) to nine (9) m in length.

11.3 2008 Drilling Program

The samples from Rockex's 2008 drilling program were sent to SGS for preparation and assaying.

The 2008 drill program generated 393 routine samples sent to SGS, for preparation, analytical and physical testing. The in-field QC samples consisted of 22 blank inserted into the sample stream, 39 duplicate samples, as well as an additional 22 second halves of core serving as a different type of duplicate samples. No standard reference material was used.

Sample preparation at the laboratory consisted of jaw crushing to nominal ¼ inch, riffing out a 1-kg sample to be roll crushed to -10 mesh and pulverized to -200 mesh. All the samples were analyzed for the major oxides and elements by Meta-Borate fusion XRF, including LOI and Total oxides %. FeO was determined by H₂SO₄ /HF acid digest-potassium dichromate titration. Fe₃O₄ was measured by Satmagan and sulphur was analyzed by LECO furnace.

A few intervals of sulphide enrichment and alteration were assayed for gold.

Samples selected to prepare 126 composites of 10 m lengths, except for a few shorter intervals at the end of the iron formation units, were analysed for % TotFe and % MagFe by Satmagan.

The database also contains the results from specific gravity determinations completed by gas comparison (helium) pycnometer on 65 pulp samples. The values range from 2.75 to 3.74 and average 3.34.

11.4 2010 Historic Core Re-Sampling

The samples from Rockex's 2010 program of re-sampling the core from three (3) 1974- 1978 Algoma holes (EI74-004, EI74-007 and EI75-050) were sent to SGS for preparation and assaying. The same analytical protocol as the one applied to the samples from the 2008 drilling program was used.

11.5 Rockex' 2011-2012 Drilling Program

The core from the 2011-2012 program was split using a diamond blade saw. One half was shipped via transport truck to SGS for analysis. The samples were submitted to Meta-Borate Fusion followed by XRF analysis of the major oxides, including % Total Oxides and LOI, as well as determination of sulphur by Leco furnace and test of the magnetic component by Satmagan. FeO was determined by titration after acid digestion.

Specific gravity ("SG") determinations were completed by gas comparison (helium) pycnometer on 174 samples and returned values averaging 3.17 and ranging from 2.68 to 4.44 (with one (1) value at 5.46).

The chain of custody and security, from the extraction of the core from the core barrel, through logging and sampling up to the time of dispatch to the laboratory were preserved by being under the control of Rockex. The core was transported from the drill rig to the core storage facilities in Thunder Bay and shipped to the laboratory by commercial carrier in wooden crates. Following assay, the remaining material was returned to Rockex and stored under secure conditions at their facilities in Thunder Bay.

12 Data Verification

12.1 Historical Validation Work

In 1973, Algoma re-sampled and assayed two (2) of LSJI's holes drilled and sampled in 1957 and 1958, for the purposes of validating LSJI's results. Details on the results are provided in WGM's 2011 report. Met-Chem will not discuss the results since the holes pre-dating 1974 are not used in the present resource estimate.

However, it is interesting to note that the assay results obtained by Algoma generally validated the work reported by LSJI.

12.2 Twin Drilling Program by Rockex (2008)

WGM (2011) commented that all five (5) of Rockex's drill holes generally intersected iron formation similar to what is described in drill core logs for the historic drill holes but in detail correlation were problematic. However, WGM agreed that, for the most part, Rockex's 2008 drilling results validate historic results. In addition, WGM recommended that Rockex re-visit the acid test results for its 2008 drill holes, since WGM suspected that the holes have steeper inclinations than reported in the Project database.

Met-Chem believes the distances between the original drill holes and the twin, ranging from 16 m to 55 m, is too large to validate previous drill results (Table 10.1), especially when testing steeply dipping iron formation affected by complex folds. Consequently, only broad correlations between the lithological and sample contacts can be expected from these twin holes, and consequently, between the analytical results from the pairs of drill holes. Met-Chem did not use the analytical results from the original (1974) drill holes in order to avoid clustering, but used the more recent twin holes drilled in 2008. This is discussed under the Section Mineral Resource Estimates of this Report (Sections 14.1 and 14.4.1).

12.3 Re-Sampling of Algoma's 1974-1978 Core by Rockex (2010)

In early 2010, Rockex undertook a program of re-logging, re-sampling and assaying of three (3) Eagle Island drill holes acquired from Essar to validate the historic logging and assay results as reported in the drill logs. The remaining split core that had previously been sampled by Algoma was logged, photographed by Rockex and three (3) drill holes were sampled along intervals designed to be equivalent to those used by Algoma.

In total, 316 routine samples were collected, to which 11 blank samples were added. No standards or duplicate samples were inserted into the sample sequence. The samples were forwarded to SGS for sample preparation and assay, using a protocol that was largely the same as the one used for Rockex's 2008 drilling program.

Five hundred and thirty-two (532) DT tests were also completed at SGS on nominal 10-m samples from Algoma's 1974-1975 and 1978 drill holes. The DT tails were also analysed for soluble iron. WGM examined some of the core and found it to be in good condition and, for the most part, was able to confirm that rock types and sample intervals largely matched those outlined in Algoma's historic logs.

The results from the 2010 re-sampling and assaying program on Algoma drill core allowed cross-comparisons between Rockex TotFe assays and Soluble Fe versus Algoma Soluble Fe assays.

12.3.1 Comparison of Rockex TotFe assays vs. Algoma SolFe Assays on Individual 10-ft Samples

WGM found that the results obtained by Rockex on TotFe assays by XRF vs. the historic Algoma Soluble Fe assays for equivalent samples indicate that for most samples, the Soluble Fe assays correlate strongly and are unbiased with respect to the 2010 Total Fe assays. WGM found that correlation between 26 samples that were initially believed to be equivalent is poor.

However, WGM and Rockex believe that, except for one, the 26 consecutive samples were probably not properly identified during the 2010 sampling program. The absence of footage blocks and/or markings in the core boxes makes some identification errors likely.

12.3.2 Comparison of Rockex vs. Algoma Soluble Fe Assays

In early 2010 a set of pulp samples from the 2008 twin hole drilling program that had previously been analysed by XRF were re-submitted to SGS for SolFe analysis. The purpose of this work was to try to replicate SGS's original SolFe assay results for the Algoma's samples.

Although WGM found that, in general, the new Aqua Regia results correlated reasonably well with Rockex's XRF assays, they appeared to under-report Fe for hematite-rich mineralization, for reasons that are not understood. This pattern does not appear to be indicated by the historic SolFe results. However the samples were analysed by Aqua Regia in two (2) different laboratories, and on samples from Rockex twinned holes

that only approximately corresponded to the samples from the Algoma drill holes. Consequently, Met-Chem believes that only broad conclusions can be made between the two (2) sets of analytical results.

12.3.3 Comparison of Rockex XRF TotFe and Soluble Assays vs. Algoma Soluble Fe Assays

The test was repeated by re-assaying soluble SolFe by Aqua Regia digestion on the same 20 samples from Algoma drill holes and previously assayed by XRF by Rockex. The results illustrate that XRF Fe assays by Rockex correlate tightly with historic SolFe assays and are unbiased. WGM found that, for the samples that report less than 22% TotFe, Rockex's results for Fe by Aqua Regia versus Fe by XRF correlate well. However, some of the samples that report above 24% TotFe by XRF return less Fe by Aqua Regia.

Further study of the results by WGM appeared to indicate that Aqua Regia digestion is reporting less Fe than XRF in the samples that have more of their Fe in the form of hematite, for undetermined reasons. For samples where most Fe is in magnetite, an unbiased strong positive correlation between XRF and Aqua Regia Fe is maintained.

12.3.4 Comparison of Magnetic % Fe by Satmagan (Rockex) and Davis Tube Tests (Algoma)

In order to compare the Algoma's Magnetic Fe results calculated from the DT tests on composite samples from three (3) Algoma holes (EI-74-004, EI-74-007 and EI-75-050) with Rockex' Satmagan Magnetic Fe results, Rockex calculated averages for its Satmagan results on individual samples grouped into intervals equivalent to Algoma's historic sample composites. Thirty-one (31) composites (comprised of 243 10-ft samples) were available for comparison.

Several composites with missing or mixed up core could not be used. However, WGM and Rockex agreed that certain intervals of drill core were in fact mixed up, in which case the results indicated that Rockex's Satmagan results correlate to a high degree and are unbiased with respect to Algoma's magnetic Fe determined from DT tests.

12.3.5 Conclusions

Rockex's 2008 program was largely aimed at validating LSJI and Algoma's drill program results through twinning several of the historic drill holes. The percentage of core recovery was very high and Rockex's sampling was adequate to provide reliable and representative samples for assay.

WGM concluded that Rockex's sampling procedures for its 2008 drilling program and the 2010 core re-sampling were generally sound and generated reliable data.

Met-Chem generally agrees with WGM that the results from the 2008 drilling program and the re-sampling program of 2010 generated reliable data. On the basis of WGM's verifications and Met-Chem's own checks, Met-Chem believes the most important outcome of the re-sampling program is the confirmation that the TotFe results by XRF analysis by Rockex provided the same results as the original soluble iron assays by Algoma. This allowed to incorporate the 1974-1975 Algoma drill results into the database used for the resources estimation.

12.4 Verification by WGM

During a site visit completed in April of 2008, WGM reviewed historical exploration data, examined 2008 core and independently collected six (6) samples of the second half drill core to serve as check samples. Core was being carefully split in half using a hydraulic splitter. In the field, drill hole sites were validated for location using a handheld GPS. In WGM's opinion, core handling and sampling procedures were to industry standards and technically sound.

The assays for WGM's second half core samples are strongly correlated with original results for the other half of the core sampled by Rockex. Generally, WGM stated that Rockex's results are validated by their observations and independent sampling results. Additional information and graphs are presented in the WGM's 2011 report.

Satmagan results showed that WGM's results are biased very slightly higher than those received by Rockex. However, Met-Chem believes no statistically valid conclusion can be drawn from a population of six (6) samples.

12.5 Verification by Met-Chem

While preparing this Technical Report, Met-Chem reviewed the previous data and made the spot checks necessary to reasonably rely on the results validated by WGM and their conclusions. WGM was the qualified person for the previously filed technical report Met-Chem has largely drawn from.

12.5.1 Database Validation – Spot Checks on 2008 and 2011-12 Data

Met-Chem carried out spot checks of the database for errors such as gaps or overlaps in the lithology or sample intervals, duplicate entries, wrong collar locations, etc.

The original laboratory certificates for the twin holes of 2008, and about 20% of the certificates for the 2011-2012 drill samples were checked against the database entries, as part of the database validation. Minor errors were found and corrected, although some results for sulphur and MagFe% or FeO% have not been imported. However, the data required for the construction of the 3D model by Met-Chem was complete. Met-Chem agrees that the database supplied by Rockex is sufficiently complete and reliable for the purposes of the resource estimation.

12.5.2 Database Validation – 2008 Rockex Drill Program – QA/QC

Twenty-one (21) blank samples averaging 6.92% Fe and ranging from 3.24% to 9.11% Fe were inserted into the sample stream. Sedimentary rocks were generally used as blanks and Met-Chem believes they were inadequate to monitor possible sample-to-sample contamination, but at least indicated no mis-sequencing with iron-rich samples.

Thirty-nine (39) duplicate samples were part of the QA/QC program, with an additional 22 second half core used as duplicate samples. Met-Chem compared the results from the assay pairs for the two (2) halves of the core and found a very high degree of correlation (0.98) between the Fe% and FeO% analytical results (Table 12-1).

Table 12-1 – Comparison of Analytical Results for Duplicate Sample (Second Half-Core)

In-Field ½ Core Duplicate Samples	Original Analysis % TotFe	Analysis on the Duplicate Samples % TotFe	Original Analysis (*) % FeO	Analysis on the Duplicate Samples (*) % FeO
Number	22	22	21	21
Average	42.45	42.35	8.29	8.37
Maximum	54.8	54.6	15.62	15.89
Minimum	8.7	8.9	5.71	5.79

12.5.3 Rockex 2008 Drill Program – XRF vs. Soluble Iron

Met-Chem also checked the statement to the effect that Algoma’s soluble iron assays correlated closely with Rockex’ more recent Total iron by XRF. This is an important point because, if correct, the results from Algoma’s holes are validated and can be incorporated into the master database and serve in the resource estimation. Met-Chem’s calculations on 266 of the 316 analytical results used in the database confirm the closeness of the results yielded by the two (2) analytical methods. The main parameters calculated from the two (2) populations are presented in Table 12-2.

Table 12-2 – Main Statistical Parameters for the Algoma’s Soluble Iron Assays and Rockex’ Total Iron Assays

Parameter	(Aqua Regia Analysis) % SolFe	(XRF Analysis) % TotFe
Number of Samples	266	266
Average	27.3	27.5
Maximum	37.4	37.5
Minimum	4	5.2
Standard Deviation	5.6	5.6
Median	28.5	28.6
Mode	30.7	30.6
Correlation Coefficient (R)	0.97	

Consequently, Met-Chem agrees with WGM that the method of soluble iron analyses used on the original samples of the Algoma 1974-75 holes yielded the same results that the duplicate samples of the Rockex 2010 re-sampling program analysed for total iron by the XRF method.

This test allowed to validate the 1974-75 drill data and, consequently, Met-Chem used them in the mineral resource calculations.

CIMA+ M03802A



12.5.4 Comparison of Satmagan (Rockex) Results vs. Davis Tube Tests (Algoma) on 2008 Samples

Met-Chem compared the results from the pairs of Satmagan tests completed for Rockex on samples from drill holes EI-74-004, EI-74-007 and EI-75-050 and those from DT tests performed by Algoma.

The samples consisted of 85 composites 10 meters long, except for those at the contacts of the iron formation units. Met-Chem found that the pairs of values are generally correlated, as indicated by a definite trend visible on a scattergram but with some scatter of the values. This partially agrees with the conclusion from WGM's examination of 31 composite sample results.

12.5.5 Cygnus' Work – 2011-2012 Drill Program

Although Cygnus logged the main lithological contacts, the samples were largely based on systematic lengths of 3 m, without regard for the lithological contacts. Met-Chem believes this is poor procedure resulting in possibly mixing populations of different characteristics and eliminating portions of iron formation at the contact with barren material by dilution.

Met-Chem found several inconsistencies and errors in the Cygnus drill logs and assay sheets, such as:

- Unit logged as greywacke in the lithology description and as mudstone in the assay sheet (EI-107, 377.6-384.2 m); 1.8 to 50.0 m in EI-107 logged as mudstone, reported as mudstone from 1.8 to 19.0 m and LIF (lean iron formation) to 50.0 m in the assay sheet;
- Lack of shoulder sample at the contact with an iron formation unit described above; no shoulder sample above iron formation contact at 337.7 m in EI-106;
- Samples 195283 to 195285 (EI-107, between 377.6 to 384.2 m) not entered into the database;
- Several units with high Fe values logged as sediments;
- Portion of a unit logged as mudstone (850.0 to 862.0 m in EI-106) returning values in excess of 21% Fe;
- Long core lengths of sediments between two (2) iron formation units cut as 3-m samples (i. e. 87 m in hole EI-116; 298.0 to 385.0 m), providing little useful information on material that can reasonably be considered as internal waste.

Cygnus inserted blank samples into the sample sequence as the only form of monitoring the laboratory performance. 85 blanks returned % Fe values ranging from 1.48 to 6.40% (one value at 10.84%), with an average of 3.02% Fe. Clearly, the material was not barren and could not have adequately monitored sample-to-sample contamination. Met-Chem believes a QA/QC protocol including the use of blank and Certified Reference Materials ("CRM" or standards) and duplicate samples should have been used, as normal



industry practice. CRMs are particularly important, since they represent the only way of checking the accuracy of the results. The use of a third party laboratory, to which 5% of the pulp samples are generally sent for re-assay, is also part of a thorough QA/QC program. The lack of QA/QC program has an impact on the reliability of the results, which is reflected in the mineral resource classification.

From the available data examined, Met-Chem believes that the core should have been handled more diligently by Cygnus and best practices guidelines should have been followed. Details on the iron mineralization have been lost and subsequent audits of the Projects have been made more complicated.

Although the integrity of the data gathered during the 2011-2012 program has not been fully preserved, a relatively large database containing over 4,000 assays in 73 drill holes was available to Met-Chem to construct the resources model. Met-Chem believes this data are sufficiently reliable and complete to be used in a resource estimate.

In addition, Met-Chem believes that the extensive work targeted at the Eagle Island deposit and the fair repeatability of the iron analyses in the different phases of drilling combine to provide a fair representation of the geological and grade continuity within the large-scale Lake St. Joseph deposit, with simple overall geometry. However, the uncertainty attached to the drill data is one of the factors taken into consideration by Met-Chem in the mineral resource classification.

12.5.6 Site Visit

The QP visit was completed, as part of the NI 43-101 requirements, by Met-Chem's Senior Geologist, Yves A. Buro, Eng., between June 16 and 18, 2013. One day was spent visiting parts of Eagle Island with Mr. Pierre Gagné, Chairman of Rockex, and another day was devoted to the examination of documents and drill core with Mr. Paul Malench, Project Coordinator, at the Rockex office in Thunder Bay. Several rounds of discussions on geology and mineral resources had been held with Gilles Filion, M.Sc. A, B. Sc. P. Eng. P. Geo., a Rockex Director.

A series of drill sites on Eagle Island from the 2008 and 2011-2012 programs were visited. The collar locations were recorded using a hand-held GPS and the inclination and azimuth of the hole casings was checked using a clinometer. Comparison of the readings in the field and the database entries for ten (10) hole collars showed that all were well within the accuracy of the GPS instrument. All the holes examined



were protected with a casing secured with a wooden plug and identified with a picket bearing an aluminum ID tag.

Examination of a few outcrops revealed the presence of an important East West shear, isoclinal fold with sub-vertical axes and some of different geometry or of sedimentary origin. A locally significant amount of quartz veins were observed as well as red jasper beds in the iron formation. All the iron formation outcrops visited were on high ground.

12.5.7 Core Review

The core from hole EI-107 was examined and the lithological and sample contacts were checked against the drill logs. The pieces of sawn core had been carefully placed in the core boxes, with the paper sample tags stapled on the bottom of the boxes at the beginning of the samples. The contacts between the samples were marked, but not always, on the core facing down, rather on the sawn surface.

No errors in the measurements were observed and a good agreement was observed between the visual estimation of the iron grade and the analytical result for iron reported on the logs.

12.5.8 Check Sampling

A batch of 18 samples were selected from three (3) drill holes (EI-108, EI-109 and EI-115) mainly to represent iron values close to the cut-off grade of 18% Fe and to the mode (30-34% Fe) of the values for all the samples in the database used for the resource estimate. The rejects were used, as Met-Chem believes they are preferable to the small split quarter core samples to serve as QP's check samples. Unfortunately, no standards were available to be inserted into the batch of check samples.

The sample rejects were retrieved by Rockex while Met-Chem was still on site. All the rejects selected by Met-Chem were available and easily found, thanks to an efficient system of storage in marked 55-gallon drums on pallets. The samples were sent to SGS for preparation, XRF analysis of major oxides, sulphur determination by LECO furnace, FeO titration and Satmagan test, using the same protocol applied to the original samples.

The analytical results and the basic statistical parameters for the original and the samples selected by the QP are presented in Table 12-3. The plot of the % TotFe results on a scatter diagram show a very high degree of correlation and no bias (Figure 12-1). The soluble iron results display a slightly lower correlation



and a distinct high bias toward the check samples (Figure 12-2). This can be expected considering that several factors influence the method, particularly at the digestion stage. The QP replicate samples selected for Met-Chem closely reproduced the original analytical results.

Table 12-3 – Analytical Results and Basic Statistics from Met-Chem’s QP Check Samples

Hole-ID	From (m)	To (m)	Sample Number	XRF		Satmagan		Soluble Fe		
				% TotFe	% TotFe Check	% MagFe	% MagFe Check	% Fe ⁺⁺ as FeO	% Fe ⁺⁺ as FeO Check	
EI-108	61	64	194381	33.99	33.92	18.4	17.6	8.77	8.86	
EI-108	64	67	194382	31.06	32.45	14.6	14.8	7.25	8.08	
EI-108	67	70	194383	31.68	31.55	17.7	16.8	8.59	9.07	
EI-108	70	73	194384	27.21	27.28	16.2	16.2	7.93	8.46	
EI-108	73	76	194385	24.83	25.53	18	18.3	8.45	9.34	
EI-108	76	79	194386	21.82	22.17	18.2	18.2	8.55	9.48	
EI-108	79	82	194387	18.12	18.61	16.2	16.5	7.75	8.68	
EI-109	137	140	194320	18.12	18.54	-	16	7.74	8.47	
EI-109	140	143	194321	18.47	19.37	-	17.7	6.37	8.89	
EI-109	143	146	194322	19.51	18.19	-	13.6	8.49	6.98	
EI-109	146	149	194323	32.38	32.59	-	13.5	7.18	7.61	
EI-109	149	152	194324	37.98	37.35	-	10.3	5.38	5.85	
EI-109	152	155	194325	32.24	31.55	-	9.2	5.76	6.26	
EI-115	26	29	194983	17.21	18.68	16	16.5	8.67	9.48	
EI-115	29	32	194984	30.92	31.41	30	28.7	14.49	14.78	
EI-115	32	35	194985	32.73	33.29	32.9	30.8	15.25	15.61	
EI-115	35	38	194986	33.71	33.92	33.6	31.4	15.6	15.89	
EI-115	38	41	194987	17.28	18.12	15.9	15.3	9.32	10.1	
				Correlation Coefficient	0.995	/	0.850	/	0.970	/
				Average	26.63	26.92	13.8	17.9	8.97	9.55
				Maximum	37.98	37.35	33.6	31.4	15.6	15.89
				Minimum	17.21	18.12	0.0	9.2	5.38	5.85



Figure 12-1 – Analytical Results from QP Samples (Total Fe %)

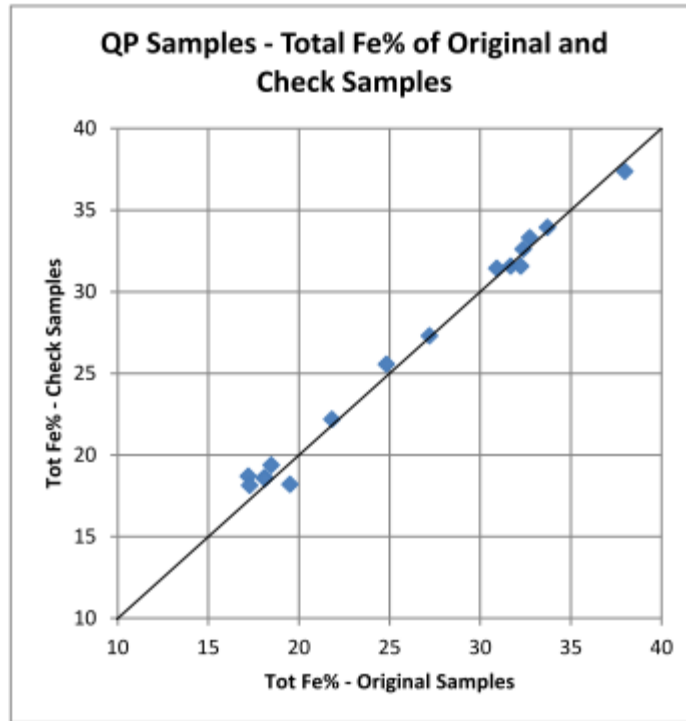
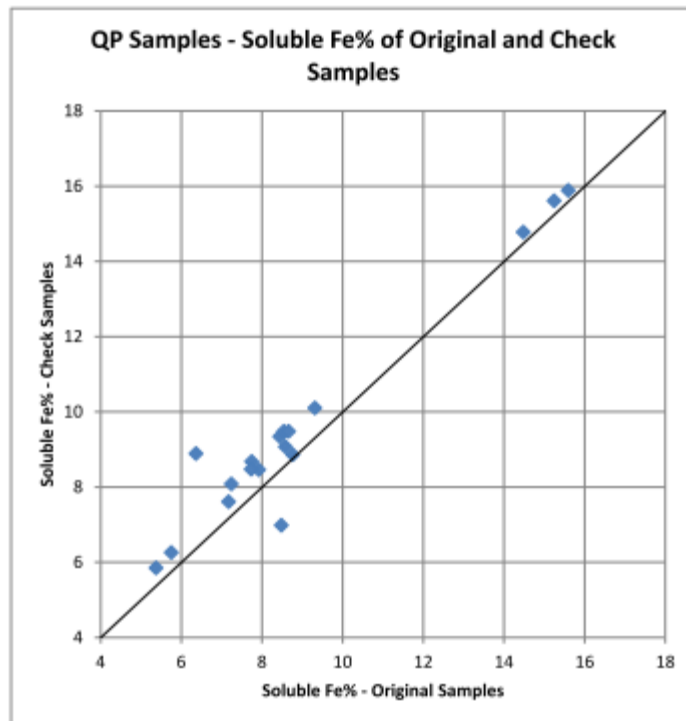


Figure 12-2– Analytical Results from QP Samples (Soluble Fe%)



CIMA+ M03802A



Specific gravity was also measured by pycnometer at SGS on the QP samples (Table 12-4).

Table 12-4 – Specific Gravity Determination on the QP Samples

Hole Id	From	To	Sample No	Specific Gravity	Specific Gravity, Check Samples
EI-108	61	64	194381	-	3.61
EI-108	64	67	194382	-	3.57
EI-108	67	70	194383	3.31	3.54
EI-108	70	73	194384	-	3.43
EI-108	73	76	194385	-	3.41
EI-108	76	79	194386	-	3.27
EI-108	79	82	194387	-	3.2
EI-109	137	140	194320	-	3.19
EI-109	140	143	194321	-	3.23
EI-109	143	146	194322	-	3.17
EI-109	146	149	194323	-	3.57
EI-109	149	152	194324	-	3.74
EI-109	152	155	194325	-	3.58
EI-115	26	29	194983	-	3.16
EI-115	29	32	194984	3.38	3.47
EI-115	32	35	194985	-	3.56
EI-115	35	38	194986	-	3.54
EI-115	38	41	194987	-	3.11
				Average	3.41
				Maximum	3.74
				Minimum	3.11

12.5.8.1 Acid Dip Tests

Met-Chem agrees with a comment made by WGM to the effect that the plunge of the 2008 drill holes, as plotted on the sections, was suspiciously shallow. This observation is of some importance, since the attitude of the holes has a direct impact on the interpreted true width of a mineralized zone.

During the site visit, Met-Chem retrieved the acid dip test tubes for one (1) hole (EI-103) and checked the etch marks. The readings of the angles by the Rockex geologists were found to correspond to ours and the corrections for the capillarity had been properly applied. These tests did show a rather severe flattening of the plunge of the drill holes. Consequently, no changes on the plunge of the holes entered in the database are advised by Met-Chem.

CIMA+ M03802A



12.5.8.2 Magnetic Susceptibility Measurements by Rockex

The magnetic susceptibility measurements are available for the core drilled by Rockex in 2008. The readings show an erratic signal composed of a series of short-range peaks and lows, from which Met-Chem found it impossible to discern plateaux at different levels that would distinguish discrete iron formation intervals of differing content of hematite or magnetite. The only obvious flat portions of the profiles indicate the presence of non-magnetic dykes and sediments.

Since the measurements from the susceptibility meter do not seem to be able to distinguish units within the iron formation with different proportions of magnetite vs. hematite, Met-Chem believes this somewhat casts doubt on the validity of the proportions described by the geologists based on visual inspection of the core.



13 Mineral Processing and Metallurgical Testing

The metallurgical test program undertaken for the the Rockex iron deposits had the mandate to characterize the deposits from processing and metallurgical point of view, and to design a process flow sheet capable of production of iron concentrate of the following parameters:

- Fe grade above 65%,
- SiO₂ near 5%
- Fe Recovery near 80% from Eagle Island mineralization
- Maximising the weight recovery.

To develop the concentrator flow sheet, a detailed metallurgical test program was performed at the SGS facilities in Lakefield, ON, under Met-Chem coordination. Most of the test results were positive and successful proving the efficiency and applicability of certain equipment: SAG mills, ball mills, gravity concentration using spirals and magnetic separators and desliming.

The tests at SGS confirmed that conventional gravity and magnetic separation would efficiently and effectively concentrate the iron bearing minerals as well.

The mineralization as tested based on the samples provided does require complex treatment for successful beneficiation. Some of the silica and fine iron silicates are eliminated simply by using spiral concentration. However, further fine grinding and magnetic separation processes are required to maximize the weight recovery of the final concentrate.

Based on the successful tests and the results from the metallurgical test program a dedicated process flow sheet was developed and designed. This will allow Rockex to process the Run of Mine (“ROM”) mineralized material to a pulp of size, sufficient to achieve the liberation of the gangue minerals and produce a concentrate with metalurgical parameters and purity requirements of the iron industry.

13.1 Mineralogical Characteristics and Iron Department Study

Rockex had provided SGS with a diverse arrangement of drill core samples for preliminary testing. A total of four (4) composites were tested.

The four (4) samples, identified as SJWGM-01, SJWGM-02, SJWGM-05 and SJWGM-06 were subjected to a detailed mineralogical examination by X-ray powder diffraction, optical microscopy, micro-probe and Quantitative Evaluation of Minerals by Scanning electron microscopy (QEMSCANTM).

For the samples submitted, the major findings were:

- Fe-Oxides minerals within samples ranged from 25 to 55% w/w;
- The main gangue minerals were quartz (varying from 20 to 30% w/w), muscovite clays (10 to 25% w/w), plagioclase (3 to 10% w/w), and K-feldspar (1 to 8% w/w);
- Iron is primarily and strongly associated with iron oxide ranging from 95 to 97.4% w/w
- Fe-Oxides, in particular hematite, begin to become liberated at the less than 150 to 75 micron size range (summed free and liberated grains ranged 18.6 to 29.9% w/w);
- Fe-Oxides, when not liberated, are associated with silicates;
- Silicates at the less than 1,000 to 300 microns size range had a summed free and liberated grains percentage range of 23.8 to 80.4% w/w.

13.2 Previous Test Work Programs

Western Lake St. Joseph deposit has been tested by different testing facilities since the early 1930s with mixed results.

Some of the most promising metallurgical test program completed in 1975 by Algoma Steel Corporation. Algoma used several desliming stages. The Algoma test work targets the removal of the gangue mineral via preferential settling. The first stage desliming feed is ground to $-50 \mu\text{m}$ to which 47% w/w reports to tailings via the desliming overflow. The material is then reground in a pebble mill to $-45 \mu\text{m}$ where a further 13% and 5.3% w/w are removed in the second and third desliming stages respectively. Focus was directed toward liberating the silicates in order to make the final target Fe grade. The Algoma pilot plant produced a 66.5% Fe concentrate with 80.3% Fe recovery and 34% weight recovery.

13.3 Summary of the Metallurgical Test Programs

SGS received drill core samples from the Eagle Island deposit for metallurgical test work from Rockex. The objective of the test program was to develop a flow sheet, whereby the final Fe concentrate grade will be above 65% Fe with a SiO_2 content near 5%, while achieving 80% recovery.

SGS conducted a specific test work program involving comminution testing, gravity separation, magnetic separation, desliming and flotation.

13.3.1 Comminution Tests

Preliminary test work included Bond Ball Work Index (“BW_i”) test and SAG Power Index (“SPI” ® Test) to establish the grinding power requirements.

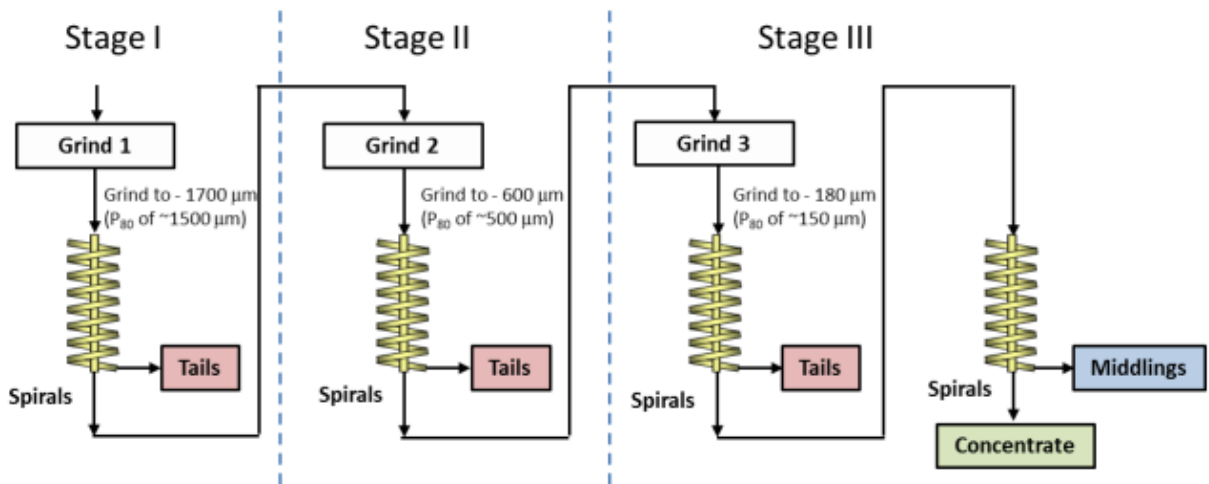
The SPI is an indication of the amount of energy required in primary grinding systems. SPI 37.3 minutes, which is equivalent to a specific grinding energy in the SAG mill of 8.12 kWh/t.

The BW_i, an indication of the amount of energy required in a ball mill grinding system, was measured to average 10.6 kWh/t.

13.3.2 Gravity Separation Tests

The mineralogical characterization indicates that the silicates become liberated at a size much coarser than the iron oxides. In order to determine if silicates could be rejected at a coarser size grind, Wilfley table testing was performed at three (3) grind sizes, P₁₀₀ of 1,700, 600 and 180 µm respectfully (see Figure 13-1 for test work simplified flow sheet).

Figure 13-1 – Gravity Separation Amenity Testing Flow Sheet



The results of the gravity amenability test work is summarized in Table 13-1 reveals that between Stage I and II, 15% weight can be rejected with an 8.1% loss in iron. Stage III showed promising results concerning its ability to make a concentrate (16.7% weight at 57.2% Fe grade). Further test work at –180 µm was pursued for both tailings rejection and concentrate production.

CIMA+ M03802A



Table 13-1 – Gravity Separation Amenability Testing Results

Grind Size P ₁₀₀	Stream	Stage Weight Distribution % w/w	Overall Weight % w/w	Fe Grade % w/w	SiO ₂ Grade % w/w	Stage Fe Distribution % w/w	Overall Fe Distribution % w/w
1,700 µm	Stage I - Feed	100	100	29.3	44.5	100	100
	Stage I – Tails	9.2	9.2	17	52.9	5.3	5.3
	Stage I – Concentrate	90.8	90.8	30.6	43.6	94.7	94.7
600 µm	Stage II - Feed	100	90.8	30.6	44.9	100	94.7
	Stage II – Tails	6.4	5.8	14.1	56.4	3	2.8
	Stage II – Concentrate	93.6	85	30.8	44.1	97	91.9
180 µm	Stage III – Feed	100	85	30.8	44.1	100	91.9
	Stage III - Concentrate	16.7	14.2	57.2	15.1	31	28.5
	Stage III - Middlings	51.9	44.1	31.9	44	53.7	49.4
	Stage III - Tails	31.4	26.7	15	59.8	15.3	14

A grade recovery curve was produced by performing multiple passes on a Wilfley Table. The target grind was a P₁₀₀ of 180 µm, with the resulting P₈₀ being 88 µm. The results of the test are summarized in Table 13-2.

Table 13-2 – Grade/Recovery Results From a Multiple Pass Wilfley Table Test at -180 µm

Cumulative Weight Distribution % w/w	Cumulative Grade % w/w		Cumulative Distribution % w/w	
	Fe	SiO ₂	Fe	SiO ₂
1.9	69.1	1.9	4.7	0.1
3.7	69	2.1	9	0.2
9.3	68.8	2.6	22.3	0.5
14.5	67.5	3.9	34.1	1.3
20.4	60.9	11.3	43.3	5.1
59.6	36.2	38.8	75.1	51.2
62.4	35.9	39	77.8	54
66.3	35.5	39.5	81.7	58.1
73.4	34.3	40.7	87.4	66.3
100	28.8	45.1	100	100

13.3.3 Magnetic Separation Tests

Magnetic separation testing was performed at a fine grind size, i.e. a P₁₀₀ of 38 µm. The magnetic intensity was low and was targeting the ferromagnetic iron oxide mineral (magnetite) in the feed. The hematite predominately reports to the non-magnetic fraction of the test work. Figure 13-2 shows the test scheme

CIMA+ M03802A



used: feed was ground to -38 µm and subjected to a rougher Low Intensity Magnetic Separation (“LIMS”) circuit consisting of one (1) stage of counter current and two (2) stages of concurrent. The rougher concentrate is then reground to -25 µm and submitted to one (1) stage of concurrent magnetic separation. The finishing concentrate is then deslimed producing a final tail.

Figure 13-2 – Magnetic Separation Test Work Flow Sheet

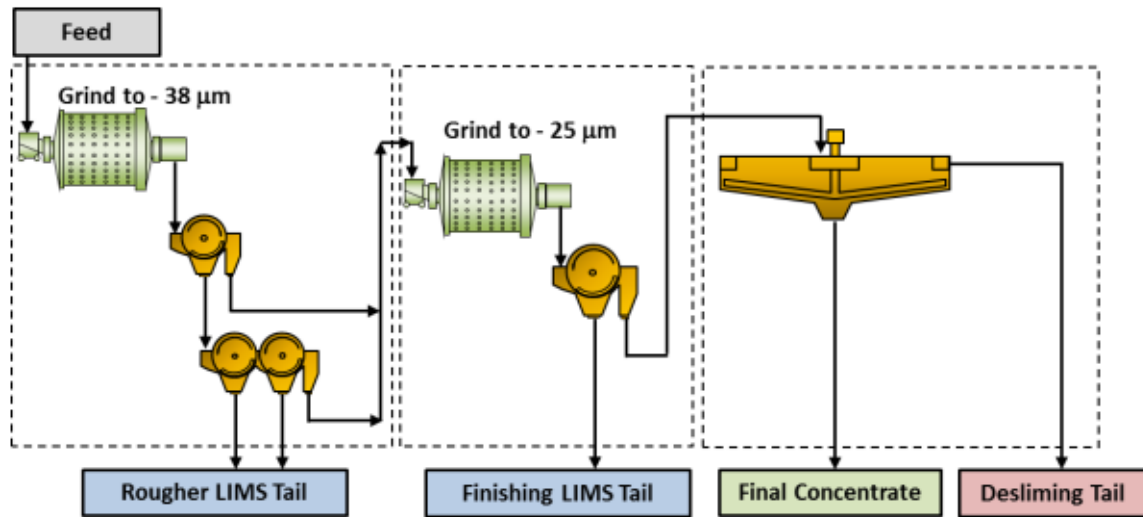


Table 13-3 shows the results of the magnetic separation tests. 51.6% of the Fe is recovered in the rougher stage with a corresponding grade of 57.3% Fe. The regrinding of the concentrate further liberates the magnetite from both hematite and silicates making a finishing concentrate with a grade of 63.9% Fe with a Fe recovery of 50%. The final desliming step was necessary to make a concentrate with a grade above 65% Fe. The desliming tails contained 0.8% of the overall Fe content with a corresponding weight of 1.34%; the final concentrate had a 66.9% Fe grade.

Table 13-3 – Magnetic Separation Test Results

Stream	Wt %	Grade % w/w		Distribution % w/w	
		Fe	SiO ₂	Fe	SiO ₂
Feed	100	28.3	45.7	100	100
Rougher LIMS Tail	74.5	18.4	55.8	48.4	90.9
Rougher LIMS Concentrate	25.5	57.3	16.3	51.6	9.1
Finishing LIMS Tail	3.36	14.1	66.1	1.7	4.9
Finishing LIMS Concentrate	22.1	63.9	8.7	50	4.2
Desliming Tail	1.34	17	63.07	0.8	1.8
Final Concentrate	20.8	66.9	5.19	49.3	2.4

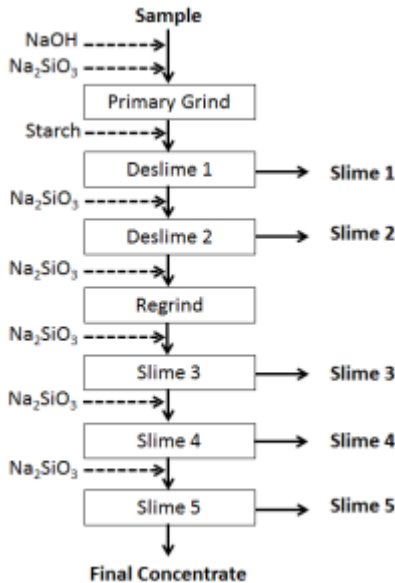
CIMA+ M03802A



13.3.4 Desliming Tests

The test work done by Algoma in the 1970s used an all-desliming flow sheet. Figure 13-3 illustrates the all-desliming used by Algoma. Recreation of the test work in terms of procedure and conditions was carried out in order to reproduce the results, i. e. ~80% Fe recovery with a Fe grade above 65%.

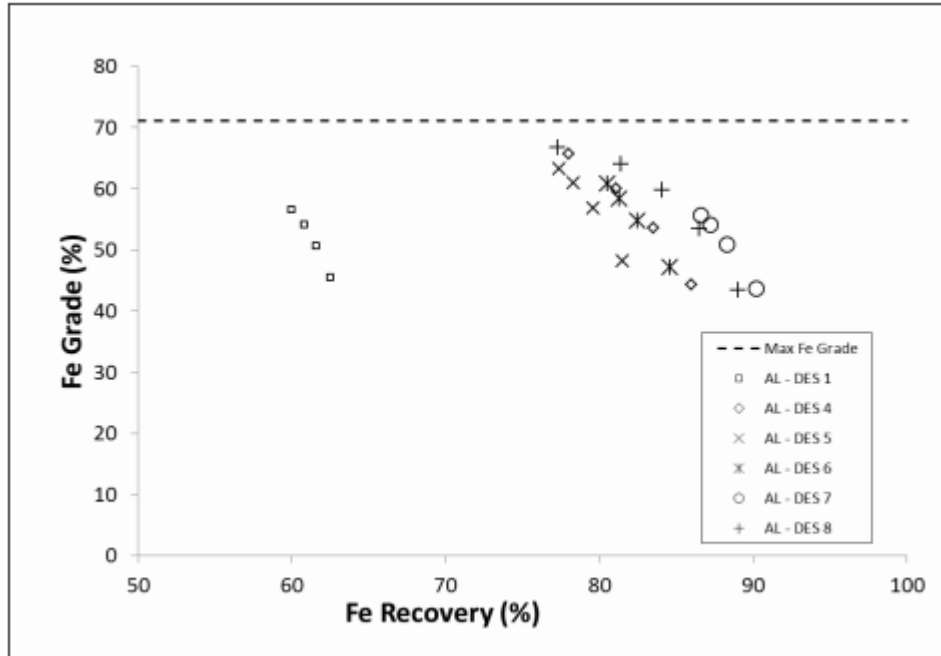
Figure 13-3 – All-Desliming Test Flow Sheet as Used by Algoma in Their 1970s’ Test Work Program



Eight (8) tests were conducted, out of which three (3) reached the SiO₂ target of near or below 5%. The final grind size to liberate the silica and ranged from a P₈₀ of 20 µm to about 25 µm (100% passing 38 µm). Figure 13-4 summarizes the results in a Fe grade versus Fe recovery graph. The highest Fe grade was achieved in AL-DES-08 with 66.9% Fe and a corresponding recovery of 71.6% Fe.



Figure 13-4 – Desliming Fe Grade Versus Fe Recovery Results



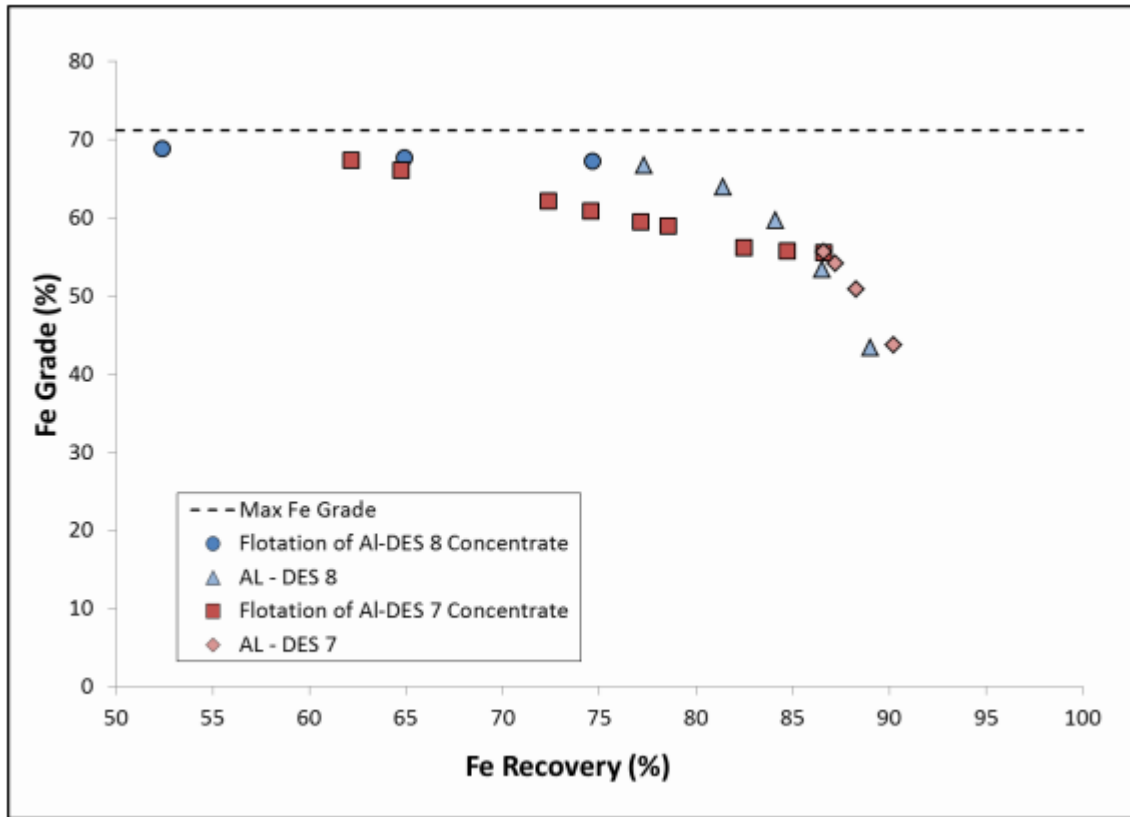
13.3.5 Flotation Tests

In order to evaluate the possibility of further increasing the grade of the concentrate, reverse silica flotation was performed upon concentrates produced during desliming test work. Flotation produced concentrates with a Fe grade above 67% and a SiO₂ grade below 3% while the corresponding Fe recoveries ranged between 50 to 70%. Figure 13-5 illustrates the Fe grade/Fe recovery curves for the flotation test work.

The fine size of the material poses a challenge to selectivity of the flotation as a process. More depression of the iron is needed in order to improve the Fe recovery. Throughout the flotation test work, a high degree of agglomeration was observed. This agglomeration may be due to magnetic attraction and demagnetizing the pulp prior to flotation should be investigated. It may also be possible to improve Fe recovery with the addition of scavenger stages on the silicate flotation product. Further optimisation of the flotation test work is warranted as it may improve overall results.



Figure 13-5 – Flotation Grade Recovery Curves with the Corresponding All-Desliming Results



13.4 Conclusions and Recommendations

13.4.1 Conclusions

- The tested mineralization was amenable to gravity separation techniques. A concentrate with a weight recovery of 14.5% and 67.5% Fe can be produced while a tail corresponding to 26.6% weight can be rejected with a loss of 12.6% Fe;
- The magnetite within the tested material was concentrated via low intensity magnetic separation. A weight recovery of 20.8% was achieved with a corresponding Fe grade of 66.9%;
- Desliming results achieved were comparable to those obtained by Algoma, with recoveries ranging between 80 to 70% and Fe grades ranging between 65 to 67%;
- The required concentrate grade parameters of Fe above 65% and SiO₂ near 5% from the Western Lake St. Joseph Project mineralization can be achieved;
- Potentially, the weight recovery can be increased by using wet high intensity magnetic separation and or with hydraulic separation.
- The final concentrate produced by the concentrator is fine enough to be used directly by a pellet plant without further grinding and can be classified a “pellet feed”.



13.4.2 Recommendations

- To improve the iron recovery while maintaining the iron content above 65% and SiO₂ below 5%, the test work studies as in Section 13.5 below have to be optimised and reproduced in a variability study;
- Desliming test work needs to investigate to benefit of more recent reagents. Although the reagents used were effective, recent advances in desliming reagents may provide chemicals that provide superior results.
- The flow sheet has to be confirmed with both lock-cycle and pilot plant testing.

13.5 Future Test Work

In order to attain the next level of study, the following test works are recommended.

13.5.1 Further Mineralogical Examination

Additional and more detailed mineralogical examination by X-ray powder diffraction, optical microscopy, micro-probe and Quantitative Evaluation of Minerals by Scanning electron microscopy (QEMSCAN™) to be performed on new representative samples to confirm the material properties of the ore.

13.5.2 Lock-Cycle Test Work

The various stages of the process need to be tested in combination to determine how the processes combine together. A lock-cycle is required to determine overall process recovery and concentrate grade.

13.5.3 Pilot Plant Test Work

The pilot plant data will give significant amounts of additional data. Since this mineralization type is complex in nature, this step is of major importance to validate the adopted flow sheet.

13.5.4 Comminution Test Work

To improve the accuracy of the SAG mill sizing in the pre-feasibility phase, crushing and grinding test work is recommended to evaluate the variability of the mineralization. Existing drill core samples should be used for this purpose. A JK Drop Weight Test should be performed on a representative composite of the mineralization as it will be mined while SMC Tests should be performed on the lithologies present to gauge the variability of the deposit.

13.5.5 Concentrate Slurry Transport Test Work

As this section will be a major expense, for the pre-feasibility study, slurry transport testing should be performed. Due to the fine nature of the pellet feed, rheology testing is needed especially with a focus on the effect due to changes in pulp density.

13.5.6 Concentrate and Pellet Feed Settling Test Work

For the pre-feasibility study, settling testing for thickeners should be done. This can be done using a testing laboratory or a vendor facility.

13.5.7 Pellet Feed Filtration Test Work

For the pre-feasibility study, testing for filtration equipment should be done.

13.5.8 Balling Design Parameter Test Work

Balling test work is suggested, but not required for pre-feasibility. The balling design parameters should comprise:

- Green pellet chemical analysis (including but not limited to the content of water, magnetite, hematite, elemental iron, dolomite, limestone, hydrated lime, blast furnace slag or scale and recycle fired pellets);
- Green pellet physical analysis (including green pellet size distribution, crushing strength, tumbler strength, porosity, specific gravity and bulk density).

13.5.9 Pot Grate Design Parameter Test Work

Pot Grate testing is suggested, but not required for pre-feasibility. To provide prospective customers with a proven quality product, balling and pot grate test work should be done.

The pot grate design parameters test work should be based on fired pellets and include:

- Pre-heating (drying) time, temperature, air flow and heat requirements;
- Induration (cooking) time, temperature, air flow and heat requirements;
- Cooling time, temperature, air flow and heat requirements;
- Optimal hearth layer thickness for the above;
- Fired pellet physical analysis (including fired pellet size distribution, crushing strength, tumbler strength, porosity, specific gravity and bulk density);

- Fired pellet chemical analysis (including assay results of fired pellet and analytical results of the minerals and mineralogical structure);
- Fired pellet metallurgical test work results (including reducibility, swelling reduction and softening).

13.5.10 Wet High Intensity Magnetic Separation (“WHIMS”)

Testing of the tails from the LIMS circuit with a high intensity type of separation equipment should be further investigated. Due to the fine nature of the material at its liberation size, a SLON is the suggested device.

13.5.11 Hydraulic Separation Test Work

Testing of the material with a hydraulic classifier at coarser size range and a reflux classifier at the finer size range may provide similar/better results than the desliming circuit.

14 Mineral Resource Estimate

14.1 Mineral Resource Estimates Statement

Following the last drilling campaign held on the Eagle Island mineralization from the fall of 2011 to the winter of 2012, Met-Chem was mandated by Rockex to carry out a resource estimate update of the Eagle Island mineralization with the intent to use the information for the preparation of a NI 43-101 compliant Preliminary Economic Assessment (“PEA”). Of the 16 holes drilled during this drilling campaign, 14 were located on the Eagle Island mineralization while the remaining two (2) holes were located on the Fish Island mineralization. The present estimate update only refers to the Eagle Island mineralization. Additional drilling is necessary on Fish and Wolf Islands in order to perform resource estimates to increase the total resource tonnage of the Property. In addition to the 14 new holes added on the Eagle Island mineralization, this resource estimate update also takes into account five (5) twin holes drilled in 2008, to verify available historical information, when Rockex became owner of the Lake St. Joseph Iron Property. These holes were not used by WGM in the previous resource estimate issued on January 28, 2011. The entire database contained 216 records resulting from exploration work between 1956 and 2011. Ninety (90) of them were used to interpolate blocks constrained within the iron solids generated for the Main Zone (“MZ”) and the South East Zone (“SEZ”) of the Eagle Island deposit.

The geological interpretation and the generation of updated 3D solids were performed by the geological team of Rockex. Met-Chem performed minor changes on these solids before their use for the resource modelling. The resource estimate was performed by QP or under their supervision. The resource classification follows the guidelines adopted by the CIM through the NI 43-101 standards and guidelines. The criteria used by Met-Chem for classifying the estimated resources are based on certainty of continuity of geology and grades. The CIM standards for resource classification are provided in Section 14.2. A summary of the Mineral Resource is provided in Table 14-1.

Table 14-1 – Summary of the Mineral Resources (Cut-Off of 10% Fe)

Category	Tonnage (Mt)	Fe (%)
Indicated	1,287	28.39
Inferred	108	31.03

14.2 Definitions

According to the final version of the CIM Standards/NI 43-101 which became effective on February 1, 2001 and was revised on June 30, 2011: A **Mineral Resource** is a concentration or occurrence of diamonds, natural, solid, inorganic or fossilized organic material including base and precious metals, coal, and industrial minerals in or on the Earth’s crust in such form and quantity and of such a grade or quality that it has reasonable prospects for economic extraction. The location, quantity, grade, geological characteristics and continuity of a Mineral Resource are known, estimated or interpreted from specific geological evidence and knowledge.

An **Inferred Mineral Resource** is that part of a Mineral Resource for which quantity and grade or quality can be estimated on the basis of geological evidence and limited sampling and reasonably assumed, but not verified, geological and grade continuity. The estimate is based on limited information and sampling gathered through appropriate techniques from locations such as outcrops, trenches, pits, workings and drill holes. An **Indicated Mineral Resource** is that part of a Mineral Resource for which quantity, grade or quality, densities, shape and physical characteristics can be estimated with a level of confidence sufficient to allow the appropriate application of technical and economic parameters, to support mine planning and evaluation of the economic viability of the deposit. The estimate is based on detailed and reliable exploration and testing information gathered through appropriate techniques from locations such as outcrops, trenches, pits, workings and drill holes that are spaced closely enough for geological and grade continuity to be reasonably assumed.

A **Measured Mineral Resource** is that part of a Mineral Resource for which quantity, grade or quality, densities, shape, physical characteristics are so well established that they can be estimated with confidence sufficient to allow the appropriate application of technical and economic parameters, to support production planning and evaluation of the economic viability of the deposit. The estimate is based on detailed and

CIMA+ M03802A



reliable exploration, sampling and testing information gathered through appropriate techniques from locations such as outcrops, trenches, pits, workings and drill holes that are spaced closely enough to confirm both geological and grade continuity.

14.3 Mineral Resource Estimate Estimation Procedures

The estimation of the Eagle Island Mineral Resource includes the following procedures:

- Validation of the drill hole database received from Rockex;
- Importation of the database in MineSight® v. 7.80-2;
- Basic statistics to assess the statistical parameters of different quality elements and make decisions on the compositing length and need for grade capping;
- Importation, adjustment and validation of the solids provided by Rockex;
- Geostatistical analysis of Fe% constrained within the mineralised solid of the Main Zone to assess the mineralization spatial continuity and determine the search ellipse parameters;
- Generation of a block model
- Interpolation of the iron content for all blocks constrained within the mineralized solids;
- Development of a linear regression model for estimating the specific gravity for each block depending on its iron content;
- Validation of the resource estimate;
- Classification of the resource according to CIM/NI 43-101 standards
- Mineral Resource Statement.

14.4 Drill Hole Database and Data Verification

14.4.1 Drill Hole Database

The drill hole database used was supplied to Met-Chem both in Excel and Access formats. The entire database consisted of 216 records, of which 136 records refer to exploration holes drilled by different companies between 1956 and 2011. The remaining 80 records refer to 44 geotechnical holes and 36 exploration trenches. Table 14-2 provides a summary of all exploration holes by drilling campaign and company name. The sampling length and the number of holes with lithological and assaying records are also mentioned. None of the LSJI holes, the exploration trenches or the Algoma Steel Corp (“Algoma”) holes

of 1967 was used for the current resource interpolation. However, the lithology intervals of all holes were used to model the geological solids.

Table 14-2 –Compilation of Exploration Holes in the Database

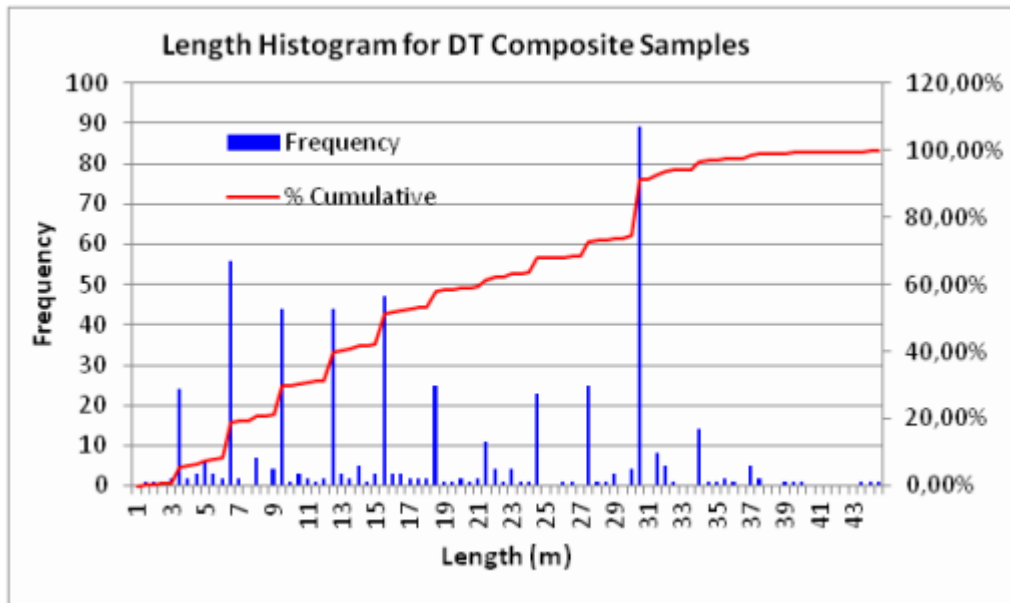
Company	Drilling Campaigns	Holes	Goal	Length (m)	Holes with Litho Records	Holes with Assays Records	Sampling Length
Rockex Limited	2011	16	Exploration	7,937.10	16	16	6,704.50
Rockex Limited	2008	5	Twinning	1,311.88	5	5	1,217.59
Algoma Steel Corp.	1974-1978	74	Exploration	14,743.64	70	72	11,204.94
Algoma Steel Corp.	1967	6	Exploration	1,314.59	0	6	550.46
Lake St. Joseph Iron Ltd.	1956-1962	35	Exploration	4,562.42	34	25	2,364.10
Total		136		29,869.63	125	124	22,041.59

Furthermore, to smooth the clustered effect of samples belonging to the twin holes, drilled in 2008, and their parent holes, drilled in 1974; it was elected to just keep the samples of the twin holes for the resource interpolation. The clustering effect is known, in resource interpolation, as the overweight of areas densely drilled/sampled comparatively to areas with less drilling. This could lead to a bias in the estimate. The parent holes discarded are EI74-001, EI74-005, EI74-009 EI74-23 and EI74-010. Thus, 90 holes were used for block interpolation.

The drill holes contained geological codes and short descriptions for each unit and sub-unit. For historical holes, the standard method used for assaying the iron content is the wet chemistry method which gives the soluble iron. Only this variable was present in the database for those holes. As historical work, Algoma also performed DT tests on 532 composite samples. Results of these tests were provided as a separate sheet. The length of these composite samples was ranging from 1.22 m to 94.44 m with 30.48 m (100 ft.) being the statistical mode.



Figure 14-1 – Length Histogram for Davis Tube Composites Samples



In the previous resource estimate WGM elected to “composite” the DT composite samples into a regular length of 10 m, same as the compositing length that was used to composite the assays. This was to allow their use for the resource interpolation. In Met-Chem’s opinion, the compositing approach itself is a method for aggregating several samples, through weighting, into a uniform and identical length. Since the statistical mode of composite samples is three (3) times the compositing length, the final results of such “compositing” would more consist in a splitting of the original samples into smaller lengths. As a consequence, this splitting would lead to the fact that the assaying results for each original sample are just repeated in split intervals although they did not reflect the natural variability of the variable under consideration. To avoid such a situation, Met-Chem found it to be more appropriate to discard the DT results in the current resource estimate.

Holes drilled since 2008 were assayed with the XRF method. Thus, the analytical iron delivered is the total iron. In 2008, Rockex performed analyses using both Wet and XRF methods on selected samples in order to characterize the quality of their relationship. The conclusions of that analysis are discussed in detail in Section 12.5.4. A good correlation between results of XRF and Wet Methods was found. Consequently, Rockex decided to merge both analytical results in the same column in the database. Met-Chem believes that, even if a combined column is of course necessary to allow resource interpolation, the database should additionally contain separate columns for each type of analytical results.

CIMA+ M03802A



14.4.2 Data Verification

Met-Chem performed the following validation steps once the database was received:

- Checking for location and elevation discrepancies and unusual values;
- Checking minimum and maximum values for each quality element to ensure that all values are ranging within the tolerable limits;
- Checking for inconsistency in the lithological units and for overlaps in the lithology and assays intervals;
- Checking for gaps in the lithological code intervals;
- Checking for repeated intervals/samples.

This first validation step was performed before importing the data into MineSight®. A further validation process was completed when importing the data into Torque, a SQL based database manager linked with MineSight®. All missing fields were replaced with a -1 value. Another validation step was to compare the assay results entries in the database, for selected holes, with the assay results as displayed in original laboratory certificates. The selected holes belong to Rockex's drilling campaign of 2008 and 2011. No major transfer errors were found.

WGM recommended in the previous resource report that further field work be undertaken in order to improve the localisation and azimuth information for the Algoma drill hole collars. Met-Chem supports this recommendation and believes that it is one of the steps to be completed before being able to upgrade the mineral resource into a measured category where the drilling density is sufficient. Fields contained in the drill hole database are summarized in Table 14-3.



Table 14-3 – Fields contained in the Drill Hole Database

Collar_Fields	Assays_Fields	Litho_Fields
Hole-ID	Hole-ID	Hole-ID
Location_X	From	From
Location_Y	To	To
Location_Z	Length	Rock_Code
Length (m)	“Sol_Iron”	Rock_Long
Azimuth (°)	SiO ₂ _%	
Dip (°)	Al ₂ O ₃ _%	
	Tot_Fe ₂ O ₃ _%	
	MgO_%	
	CaO_%	
	Na ₂ O_%	
	K ₂ O_%	
	TiO ₂ _%	
	P ₂ O ₅ _%	
	Cr ₂ O ₃ _%	
	V ₂ O ₅ _%	
	LOI_%	
	S_%	
	Fe_% Mag	
	Fe ₃ O ₄ _% Mag	
	Fe ₂ _FeO_%	
	MnO_%	

Table 14-4 summarizes basic descriptive statistics calculated on the entire raw data, regardless of any geological interpretation. Tot_Fe₂O₃% designates the total iron, of the XRF analysis, expressed as Fe₂O₃ while Fe₃O₄%Mag represents the results of the Satmagan measurement and Fe_%Mag its stoichiometric conversion into iron.

As aforementioned, the column “Sol_Iron” in fact represents a mix-up of historical soluble iron, by Wet Chemistry Method, and total iron, by XRF analyse. Hence, the term “Sol_Iron” could be misleading. In the present case, Met-Chem elected to replace the name of the fields “Sol_Iron” or “Sol_Fe%” respectively by “Iron” or “Fe%”.

Since Fe% is the only quality element present for both historical holes (69 holes) and Rockex’s new holes (21 holes), only this element was interpolated.

CIMA+ M03802A



Table 14-4 – Descriptive Statistics of Quality Elements in the Entire Database

	Arith. Av.	Median	Mode	St. Dev.	Variance	COV	Range	Min.	Max.	Samples
"Sol_Iron"	26.32	29.30	32.80	10.71	114.66	0.41	61.72	1.28	63.00	8344
Tot_Fe2O3_%	32.46	36.00	47.10	16.30	265.56	0.50	58.27	1.83	60.10	2906
Fe2_FeO_%	7.42	7.01	6.44	2.65	7.00	0.36	24.98	1.67	26.65	2630
Fe_% Mag	11.78	12.70	0.40	6.83	46.67	0.58	35.30	0.01	35.30	2705
Fe3O4_% Mag	16.26	17.60	0.40	9.43	88.96	0.58	48.70	0.01	48.70	2704
SiO2_%	49.21	47.20	43.00	8.78	77.17	0.18	42.00	33.00	75.00	2906
Al2O3_%	8.05	6.87	15.00	4.40	19.34	0.55	18.37	1.43	19.80	2906
MgO_%	1.80	1.48	1.34	1.11	1.24	0.62	16.03	0.47	16.50	2906
CaO_%	1.76	1.37	1.02	1.24	1.53	0.70	11.28	0.52	11.80	2906
Na2O_%	1.56	1.35	0.86	0.91	0.83	0.58	4.95	0.05	5.00	2906
K2O_%	1.96	1.85	1.71	0.83	0.70	0.43	7.04	0.01	7.04	2906
TiO2_%	0.26	0.22	0.11	0.16	0.03	0.62	1.73	0.04	1.77	2906
P2O5_%	0.38	0.33	0.33	0.22	0.05	0.56	1.16	0.05	1.21	2906
Cr2O3_%	0.011	0.01	0.005	0.011	0	1.002	0.249	0.001	0.25	2906
V2O5_%	0.010	0.010	0.005	0.021	0.000	2.092	1.079	0.001	1.080	2903
MnO_%	0.05	0.04	0.03	0.03	0.00	0.58	0.31	0.01	0.31	2906
LOI_%	2.321	1.535	0.03	2.977	8.861	1.283	99.69	0.01	99.7	2882
S_%	0.058	0.02	0.01	0.15	0.023	2.593	4.749	0.001	4.75	1599

14.4.3 Geological Modelling Procedures

The update of the geological solids, to account for the 14 holes drilled in 2011, was completed by M. Gilles Filion, P. Geo., M. Sc., Director of Rockex. The solids were transmitted to Met-Chem which did some minor adjustments before their use to code the assays and blocks. The methodology used by M. Filion to generate the 3D solids was based on the traditional sectional interpretation on 2D prior to generation of 3D envelopes by triangulation. One solid was generated for each of the MZ and SEZ.

The geological model is based on a single iron envelope for each zone. However, it was noted that iron shows a higher variability in the case of the SEZ. This variability has an impact on the efficiency of blocks estimate since it is not possible to constrain high grade domains separately from low grade domains. It is necessary to conduct further investigations/works in order to better characterize the high variability observed in that zone and ultimately define sub-solids to better control resource interpolation in upcoming estimates.

A topographic surface was provided by Rockex. Met-Chem also generated a Triangulated Irregular Network ("TIN") using collar elevations of drill holes and the bottom of the overburden to guide the creation of final



solids representing the iron formation and ensure that the mineral resource estimate stayed below these surfaces.

14.5 Statistical Analysis and Compositing

The geological solids were used to constrain the assays of holes selected for resource interpolation. Basic descriptive statistics were calculated on the resulting raw data in order to get a better understanding of statistical parameters and take necessary actions before moving forward into the next steps of a resource estimate. In Table 14-5 and Table 14-6, statistics were calculated only on the assays constrained in the MZ and SEZ.

Table 14-5 – Descriptive Statistics of Assays within the Iron Formation in the Main Zone

	Arith. Av.	Median	Mode	St. Dev.	Variance	COV	Range	Min.	Max.	Samples
Fe_%	27.45	29.20	30.00	7.34	53.88	0.27	39.10	2.00	41.10	3203
Al ₂ O ₃ _%	6.11	5.28	5.30	2.76	7.60	0.45	15.61	1.49	17.10	1399
CaO_%	1.44	1.19	1.02	0.92	0.85	0.64	7.94	0.58	8.52	1399
Cr ₂ O ₃ _%	0.01	0.01	0.01	0.01	0.00	0.71	0.23	0.01	0.24	1398
Fe_% Mag	14.82	14.30	13.20	4.70	22.11	0.32	35.20	0.10	35.30	1399
Fe ₂ FeO_%	7.64	7.29	7.11	1.90	3.62	0.25	14.33	2.58	16.91	1139
Tot_Fe ₂ O ₃ _%	39.57	42.10	44.00	10.38	107.82	0.26	53.66	4.94	58.60	1399
Fe ₃ O ₄ _% Mag	20.47	19.65	18.20	6.49	42.07	0.32	48.60	0.10	48.70	1398
K ₂ O_%	1.85	1.77	1.34	0.72	0.52	0.39	7.03	0.01	7.04	1399
LOI_%	1.46	0.88	0.10	3.13	9.81	2.14	99.69	0.01	99.70	1382
MgO_%	1.65	1.45	1.46	0.87	0.76	0.53	10.99	0.61	11.60	1399
MnO_%	0.04	0.04	0.03	0.02	0.00	0.51	0.15	0.01	0.16	1399
Na ₂ O_%	1.27	1.12	0.86	0.59	0.35	0.47	3.74	0.10	3.84	1399
P ₂ O ₅ _%	0.43	0.38	0.33	0.17	0.03	0.40	1.01	0.11	1.12	1399
S_%	0.03	0.02	0.01	0.08	0.01	2.55	1.26	0.01	1.27	730
SiO ₂ _%	45.81	44.80	46.50	5.41	29.28	0.12	35.20	33.00	68.20	1399
TiO ₂ _%	0.19	0.16	0.13	0.12	0.01	0.60	1.15	0.04	1.19	1399
V ₂ O ₅ _%	0.011	0.010	0.010	0.030	0.001	2.520	1.070	0.010	1.080	1396

The elements average for both zones appear similar except that there seems to be slightly more magnetite in the MZ. Furthermore, when the Coefficient of Variation (“COV”) is considered, it appears that the SEZ generally shows higher grades variability. Only Fe% is interpolated since other elements are only available for holes drilled in 2008 and 2011. Those elements could be interpolated in further resource estimates once additional drill holes have provided a more representative data set.



The sample length histogram was also generated in order to have a visualisation of the sampling length frequency and to choose the best length to be used to composite all assays into a uniform length (Figure 4-2).

The histogram shows two (2) particular lengths of high frequencies, namely 3 m and 3.05 m. The first represents the most sampling length of the recent drilling campaigns while the second represents the most sampling length (10 ft.) for historical holes.

The general rule, for choosing the compositing length, is to consider the statistical mode of the assay sampling intervals, since it is the best one which will allow most of the assays to stay unmodified after compositing. In this case, the mode is 3.05 m (10 ft.) and represents the compositing length chosen by Met-Chem.

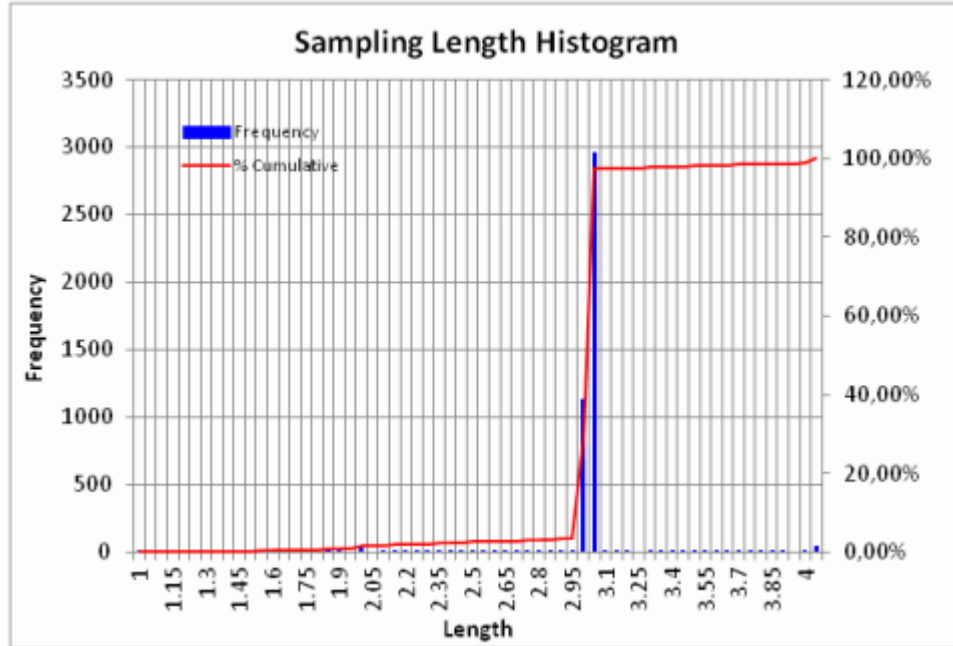
Table 14-6 – Descriptive Statistics of Assays within the Iron Formation in the South East Zone

	Arith. Av.	Median	Mode	St. Dev.	Variance	COV	Range	Min.	Max.	Samples
Fe_%	27.04	29.59	34.00	9.58	91.81	0.35	42.28	2.72	45.00	1142
Al ₂ O ₃ _%	7.41	6.83	10.10	4.14	17.15	0.56	16.57	1.43	18	418
CaO_%	1.99	1.39	1.21	1.68	2.81	0.84	8.96	0.61	9.57	418
Cr ₂ O ₃ _%	0.01	0.01	0.01	0.02	0.00	1.09	0.24	0.01	0.25	418
Fe_% Mag	13.24	13.70	15.60	6.64	44.05	0.50	29.40	0.10	29.5	261
Fe ₂ FeO_%	7.36	7.03	7.02	2.12	4.50	0.29	12.27	1.67	13.94	418
Tot_Fe ₂ O ₃ _%	35.79	37.65	50.10	14.50	210.27	0.41	56.21	3.89	60.1	418
Fe ₃ O ₄ _% Mag	18.29	18.90	21.50	9.17	84.09	0.5	40.6	0.1	40.7	261
K ₂ O_%	1.85	1.62	0.65	1.08	1.17	0.58	5.92	0.03	5.95	418
LOI_%	2.13	1.27	1.12	2.43	5.90	1.14	15.99	0.01	16.00	418
MgO_%	2.03	1.41	1.14	1.64	2.69	0.81	15.82	0.68	16.50	418
MnO_%	0.04	0.04	0.03	0.03	0.00	0.58	0.15	0.01	0.16	418
Na ₂ O_%	1.42	1.25	0.60	0.91	0.83	0.64	4.92	0.05	4.97	418
P ₂ O ₅ _%	0.45	0.40	0.31	0.22	0.05	0.49	1.14	0.07	1.21	418
S_%	0.04	0.02	0.01	0.05	0.00	1.27	0.52	0.01	0.53	389
SiO ₂ _%	46.54	44.85	43.60	7.31	53.48	0.16	34.70	34.7	69.4	418
TiO ₂ _%	0.24	0.22	0.08	0.15	0.02	0.61	0.75	0.04	0.79	418
V ₂ O ₅ _%	0.010	0.010	0.010	0.000	0.000	0.40	0.02	0.01	0.03	418

CIMA+ M03802A



Figure 14-2 – Sampling Length Histogram for Assays Within the 3D Solids



Regular down the hole compositing approach was used to composite assays restricted to the mineralization solids. All composites shorter than 1.5 m were discarded in order to avoid bias introduced by short intervals. Table 14-7 provides Fe% statistics for the composites data. The Fe% average for MZ and SEZ is preserved after compositing. The composites histograms of Fe%, for both MZ and SEZ, are displayed on Figure 14-3 and Figure 14-4. The iron distribution in the MZ is more uniform and close to a Gaussian distribution than the one in the SEZ which appears more scattered with a high variability. This more scattered pattern explains the higher coefficient of variation on the SEZ.

Table 14-7 – Composites Statistics

	Main Zone % Fe	South East Zone % Fe
Average	27.47	27.07
Median	29.11	29.49
Mode	28.87	33.59
Standards Deviation	7.01	9.19
Variance	49.07	84.38
COV	0.26	0.34
Range	39.17	39.42
Minimum	1.91	3.37
Maximum	41.08	42.79
Samples	3190	1125

CIMA+ M03802A



Figure 14-3 – Composites Histogram of % Fe on the Main Zone

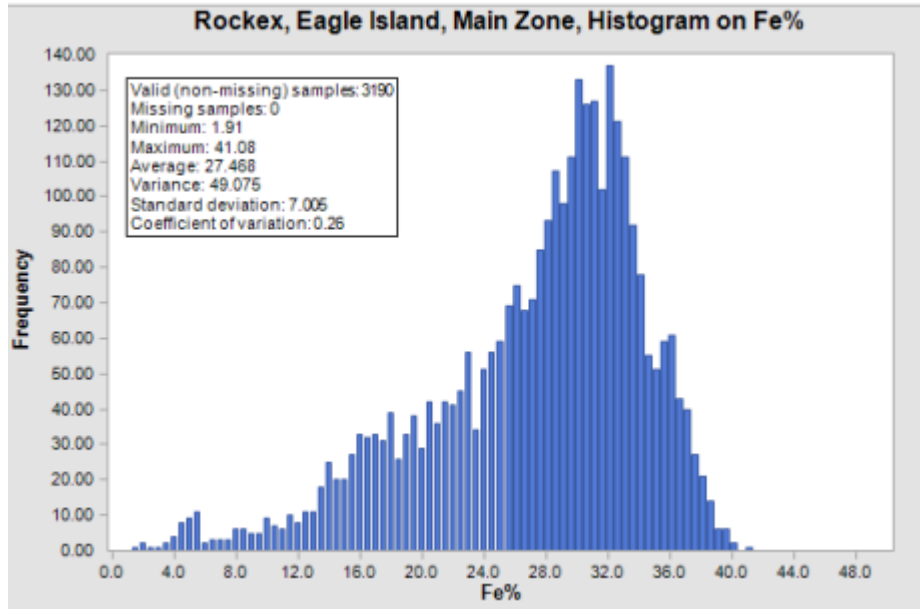
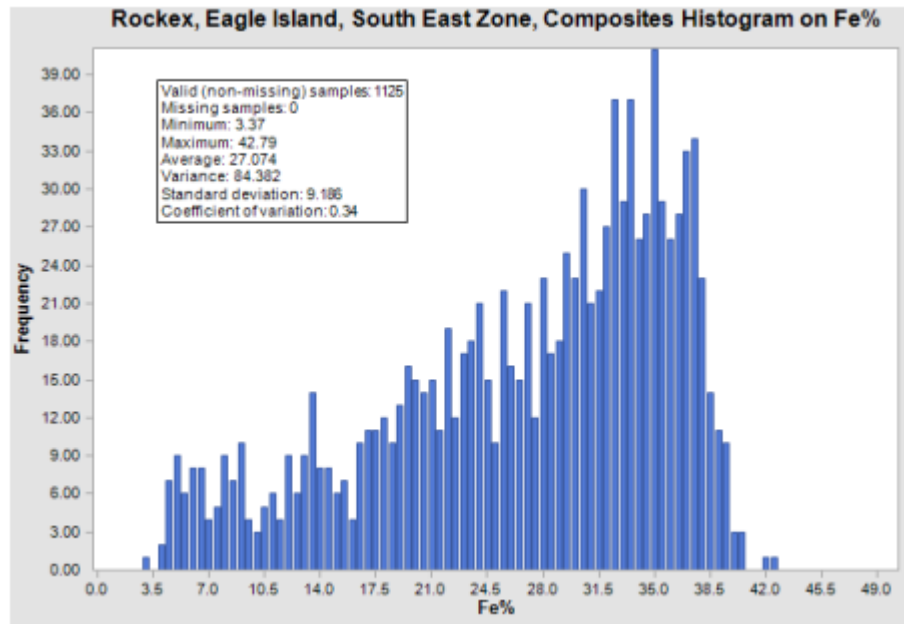


Figure 14-4 – Composites Histogram of % Fe on the South East Zone



Additional investigations/drilling would allow to better define the SEZ and ultimately define sub-solids for constraining high grades and low grades domains. Such constraining will allow increasing the confidence level in the resource estimate.

CIMA+ M03802A



Grade capping is an approach commonly used in mineral resource estimate in order to limit/discard bias associated with high grade values. Considering the nature of the mineralization and the pattern of Fe% histograms, Met-Chem determined that grade capping is not required for the resource estimation of the Eagle Island deposit.

14.6 Variogram Modelling

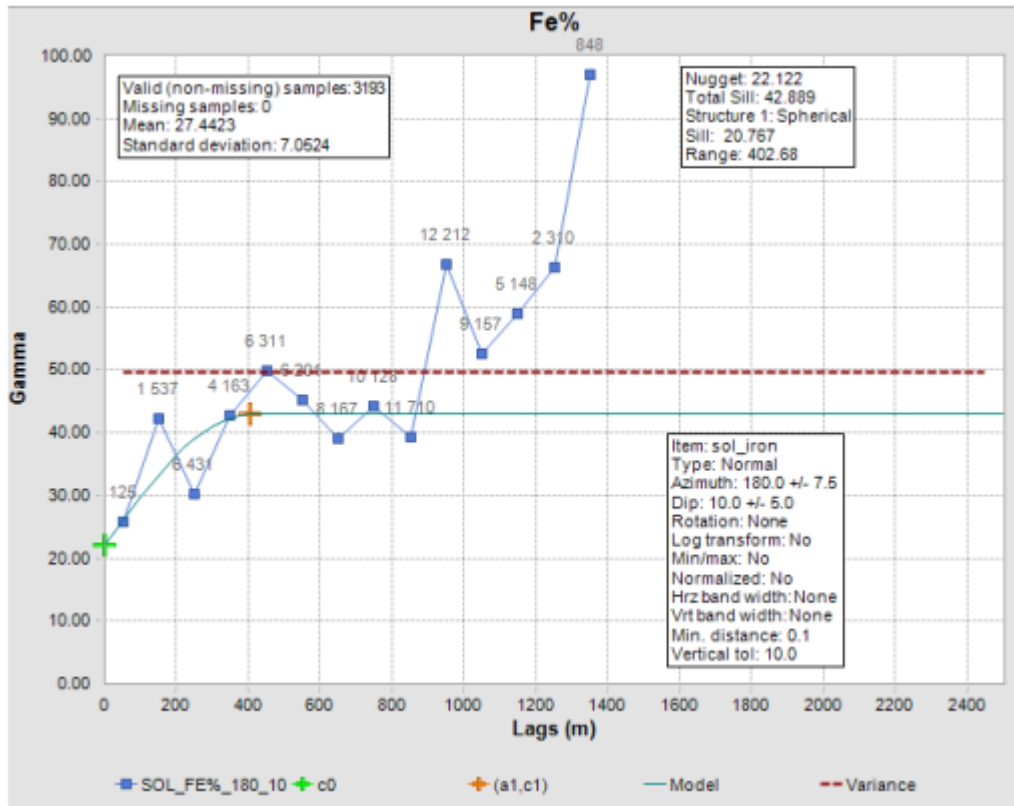
Variograms were generated for the MZ, using the composites raw data, in order to analyse the spatial continuity of the mineralization and determine the suitable parameters for grade interpolation. The module MineSight® Data Analyst – 2.80-03 was used to model all variograms. The MZ has the less complex pattern to allow a geostatistical analysis to be performed without any unfolding process. For this reason, it was elected to analyse the spatial continuity on this zone and apply the resulted parameters for interpolating all zones.

Directional variograms were generated for Fe% in directions corresponding to the major axis (axis of better continuity), the semi-major axis (perpendicular to the major) and the minor axis (in principle perpendicular to the major and semi-major axis). In this case, the longer axis of continuity was found on the strike direction with an azimuth of N180° and a plunge of -10°. The corresponding range is about 400 m. This axis, on the N180° direction, is typical of the North-South oriented portion of the MZ solid. Another axis of relative good continuity was also found with an azimuth of N45° and is typical of the NE oriented portion of the mineralized solid. However, the variogram on the N180° was better defined.

Normally, the semi-major axis should be found on the N270° direction, but all variograms generated in that direction are of poor quality. This is mainly due to insufficient drilling across the dip direction and to extreme deviations of most holes drilled. In fact, many holes started with a high dip (-50° to -60°) but were completed after having being extremely flattened (-20° to -30°). The only fairly good variogram found in the dip direction was with an azimuth of N255° and a plunge of -80°. The corresponding range was about 300 m. It was not possible to directly define a relevant variogram on the minor axis because of holes' high deviations. The alternative was to consider the combined down-hole variogram as representative of the minor axis.

Figure 14-5 and Figure 14-6 show experimental variograms against model variograms for the strike direction (major axis), the direction N255° (assumed semi-major axis) and the down-hole direction.

Figure 14-5 – % Fe Variogram Across the Strike Direction



In conclusion, the search ellipse parameters determined for grade interpolation are as follows; 400 m in the major axis, 300 m in the semi-major axis and 30 m in the minor axis. Due to its geometrical complexity, the Eagle Island deposit was subdivided into different structural domains in each zone. This is to allow the search ellipse to be oriented according the main orientation of each domain in such a way that all blocks are properly coded during grade interpolation.

Due to the iron high variability on the SEZ it is possible that variograms on this zone would have shorter ranges than those obtained on the MZ. However, the tight structural domains defined on this zone, due to its folded nature, represent barriers where the search ellipse is constrained, no matter its size. The definition of structural domains is discussed in Section 14.9.

CIMA+ M03802A



Figure 14-6 – % Fe Variogram on N255°, Plunge of -80° (assumed as the dip direction)

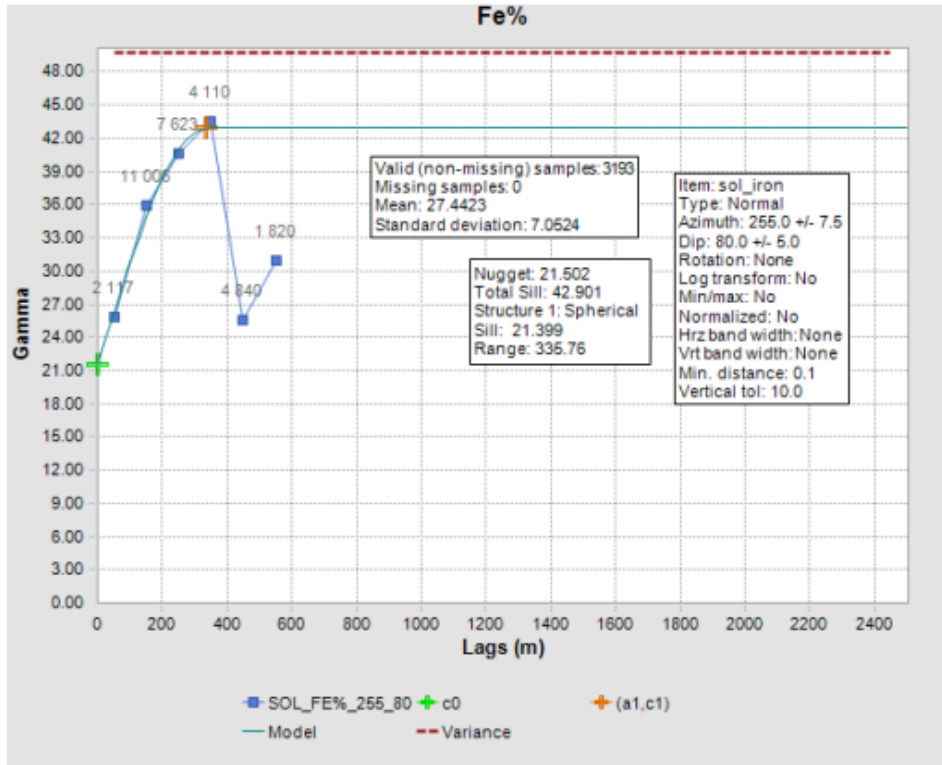
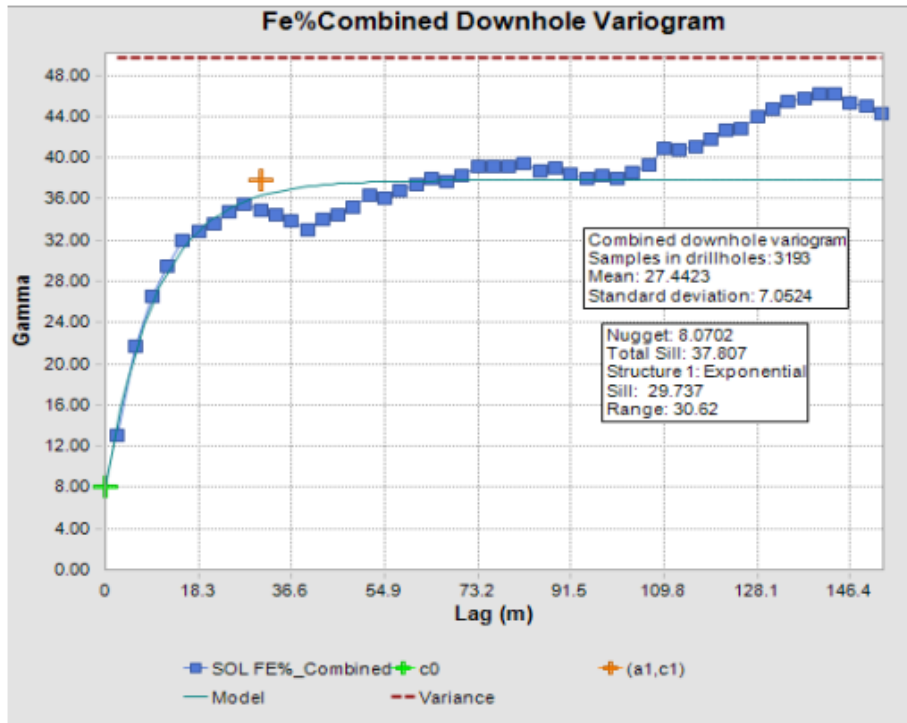


Figure 14-7 – Fe% Combined Down Hole Variogram



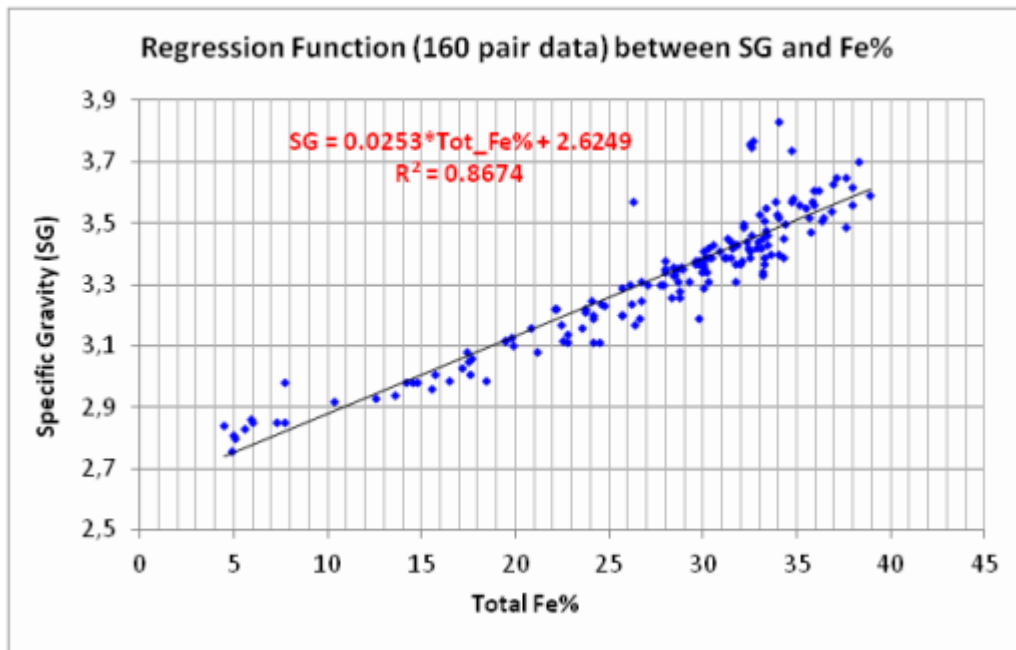
CIMA+ M03802A



14.7 Density/Specific Gravity

Specific Gravity is discussed in details in 12.5.8 (Mineralisation) of this Report. For the current mineral resource estimate, Met-Chem created a regression model between density and the iron content. The regression model was built using 160 results of SG measurements performed on selected pulps using the pycnometer method. Figure 14.8 displays the scatter diagram and the regression equation. The specific gravity shows a good correlation with the iron content.

Figure 14-8 – Regression between SG and Fe%



In its previous resource estimate, WGM built a regression model based on the raw data available at that time (65 pair data) and came up with a very similar regression equation ($SG = 0.0275 \times \% \text{ TotFe} + 2.5373$).

14.8 Block Model Setup/Parameters

A block model was created using MineSight® software package to generate a grid of regular blocks for estimating tonnes and grades. A unique block model was created for both MZ and SEZ. In the estimate of 2011, WGM considered a block size of 25 m × 25 m × 25 m respectively in the X, Y and Z directions. Met-Chem is of the opinion that such a size appears a little bit too small comparatively to the drilling spacing. An industry standard is to consider block size in the range of one half (½) to one fourth (¼) of the average drilling spacing. Block size is particularly a sensitive parameter for estimates based on geostatistical methods such

as kriging. In this case, the kriging variance is intimately related to the distance of the center of block being estimated to the composites involved in its interpolation. The smaller the blocks, the higher the kriging variance will be. Furthermore, even for estimates not based on geostatistical methods such as Inverse Distance Method (“IDW”), a too small block size would lead to estimates that did not reflect the confidence provided by the drilling spacing.

The average drilling spacing computed by Met-Chem is 233 m between holes on the MZ and 169 m between holes on the SEZ. This leads to an average of around 200 m between holes when both zones are considered together. For the X and Y directions, Met-Chem decided to consider a size of 50 m × 50 m which corresponds to one fourth (¼) of the average drilling spacing. A height of 10 m was considered in the Z direction to align with the projected type of mining equipment. The specific parameters used for the block modelling are summarised in Table 14-8.

Table 14-8 – Eagle Island – Blocks Model Parameters

Direction	Minimum (UTM)	Maximum (UTM)	Block Size	Number of Blocks	Model Origin (UTM)
Easting (X)	628,000	640,000	50	240	628,000
Northing (Y)	5,645,000	5,650,000	50	100	5,645,000
Elevation (Z)	-200	450	10	65	-200
Rotation	N/A	N/A	N/A	N/A	N/A

14.9 Structural Domains for Interpolation

Due to the deformed nature of the mineralization on the MZ and SEZ of the Eagle Island deposit, it was necessary to define structural domains in order to allow the search ellipse to be adequately oriented and all blocks to be properly coded during resource interpolation. Ten (10) structural domains were necessary for this. The parameters of the structural domains are presented in Table 14-9.



Table 14-9 – Parameters of Structural Domains

	Domains	Azimuth (^o)	Dip (^o)
Main Zone	MZ_1	70	-84
	MZ_2	55	-65
	MZ_3	0	-65
	MZ_4	330	-65
South East Zone	SEZ_1	255	-85
	SEZ_2	230	-80
	SEZ_3	20	-86
	SEZ_4	335	-85
	SEZ_5	250	-71
	SEZ_6	310	-70

14.10 Resource Interpolation

The resources of the Eagle Island deposit were estimated using the Inverse Distance Squared Method (“IDW2”) which, in its basis formulation, belongs to the non geostatistical estimation methods. However, the search ellipse anisotropy was taken into account, which makes the estimation methodology closer to the kriging method. In kriging estimation, the estimate of a block is a linear combination of all surrounding composites that are selected. In this linear combination, the weight of each composite is a function of its distance to the block center and the quality of the variogram, range and nugget effect, in the related direction.

In the approach that was used, the weighting factor is a function of the distance from the block center to the composites where closer composites have more weight. The consideration of the ellipse anisotropy attributes more weight on composites situated in the better axis of continuity. Met-Chem is of the opinion that IDW methods give estimates similar to geostatistical methods in the case of continuous sedimentary deposits such as Banded Iron Formation (“BIF”).

Three (3) interpolation passes were used in the estimation. Except for the vertical component for the third pass, the basis search ellipse was kept the same for all passes while the minimum number of composites, and consequently the minimum number of required holes, was relaxed from one pass to the next one. Interpolation parameters are summarized in Table 14.10.

CIMA+ M03802A



Table 14-10 – Interpolation Parameters

Items	Description		
Grade Interpolation Method	IDW2		
Composites	By fixed length of 3.05 m (10 feet), discarding composites < 1.5 m		
High Values Capping	N/A		
Search Method 1: Octant	Maximum of 10 composites per Octant		
Ellipse Orientation	Depending of related structural domain (See Table 14-11)		
Interpolation Pass	Pass 1	Pass 2	Pass 3
Min. Number of Composites/Block	9	6	3
Max. Number of Composites/Block	15	15	15
Max. Number of Composites/Hole	3	3	3
Ellipse Size on the Major Axis (Strike)	400 m	400 m	400 m
Ellipse Size on the Semi-Major Axis (Dip)	300 m	300 m	300 m
Ellipse Size on the Minor Axis (Downhole)	30 m	30 m	60 m

Table 14-12 and Table 14-13 show, for the MZ and SEZ, the comparison between Fe% average for assays, composites and interpolated blocks. The iron average is well repeated in the block model for the Main Zone. The iron average for the SEZ is slightly higher than the average of composites. This is due to the iron high variability in this zone as already discussed in the previous Section.

Table 14-11 – Structural Domains for Resources Interpolation

	Domains	Azimuth (^o)	Dip (^o)
Main Zone	MZ_1	70	-84
	MZ_2	55	-65
	MZ_3	0	-65
	MZ_4	330	-65
South East Zone	SEZ_1	255	-85
	SEZ_2	230	-80
	SEZ_3	20	-86
	SEZ_4	335	-85
	SEZ_5	250	-71
	SEZ_6	310	-70



Table 14-12 – Fe% Comparison for Assays, Composites and Blocks on Main Zone

	Fe (%)
Assays	27.45
Composites	27.47
Blocks	27.76

Table 14-13 – Fe% Comparison for Assays, Composites and Blocks on South East Zone

	Fe (%)
Assays	27.04
Composites	27.07
Blocks	28.37

14.11 Resource Classification

Mineral Resource classification is based on certainty of geology and grades and this is, for BIF, in most cases related to the drilling density. Areas more densely drilled are usually better known and understood than areas with sparser drilling which could be considered to have a lower confidence level. However, in some rare cases, even a tight drilling may not allow having certainty on grades continuity. This is particularly the case of deposits showing high variability on grades and high nugget effect.

Met-Chem has considered the following factors for the resource classification of the Eagle Island deposit:

- The ratio hematite/magnetite which is variable in the deposit but remains still not well understood;
- The high variability of iron in the SEZ which affects the quality of the estimates in that zone;
- The localisation of Algoma’s historical holes that has to be verified/confirmed through extensive field work
- The QA/QC program of the drilling campaign of 2011 which did not strictly adhere to a full QA/QC program (no standards, no duplicates);
- The mixed nature (% SolFe and % TotFe) of iron (%Fe) that was interpolated, even though there is a good correlation between both of them.

Taking all of these factors into account, Met-Chem found it to be appropriate to classify all blocks estimated during the first and second passes as Indicated Mineral Resources. Blocks estimated in the third pass are classified as Inferred Mineral Resources.

CIMA+ M03802A



14.12 Mineral Resource Statement

Mineral Resources are stated using a Fe cut-off of 10%. The cut-off used is related to actual market conditions which provide reasonable prospect for economic extraction at that cut-off. The cut-off grade of 10% was calculated using the economic parameters from Section 16.0 in this Report. A block of iron mineralization that has a grade of 10% will generate zero revenue after paying for mining and processing.

Table 14-14 – Indicated Resources

Cut-off 10% Fe	Indicated Resources (Mt)	Fe (%)
Main Zone	1,086	28.39
South East Zone	201	28.40

Table 14-15 – Inferred Resources

Cut-off 10% Fe	Indicated Resources (Mt)	Fe (%)
Main Zone	83.2	30.21
South East Zone	25.1	33.74

Met-Chem is unaware of any legal, political, environmental, or other risks that could materially affect the potential development of the Mineral Resources. Due to the uncertainty attached to Inferred Mineral Resources, it cannot be assumed that all or part of an Inferred Mineral Resource will be upgraded to an Indicated or Measured Mineral Resource as a result of continued exploration. Mineral Resources that are not Mineral Reserves do not have demonstrated economic viability.

However, it is important to note that the estimated resources in the Inferred Resources category for the Property, only represents a small percentage (7.7%) of the total resources.

15. Mineral Reserve Estimate

Since this report is a Preliminary Economic Assessment report, no Mineral Reserves have been estimated for the Lake St. Joseph deposit as per NI 43-101 regulations. In-pit Mineral Resources are described in Section 16.



16 Mining Methods

Met-Chem evaluated the potential for an open pit mine at Eagle Island to produce 6 Mt of iron pellet feed per year which will then be converted into 4.3 Mt of HBI. This section of the Report discusses the pit design, mine plan and fleet requirements that were estimated for the PEA and which form the basis for the Mine Operating and Capital Cost estimate presented in Section 21 of this Report.

The mining method selected for the Project is a conventional open pit drill and blast operation with rigid frame haul trucks and hydraulic shovels. Vegetation, topsoil and overburden will be stripped and stockpiled for future reclamation use. The mineralization and waste rock will then be drilled, blasted and loaded into haul trucks with hydraulic shovels.

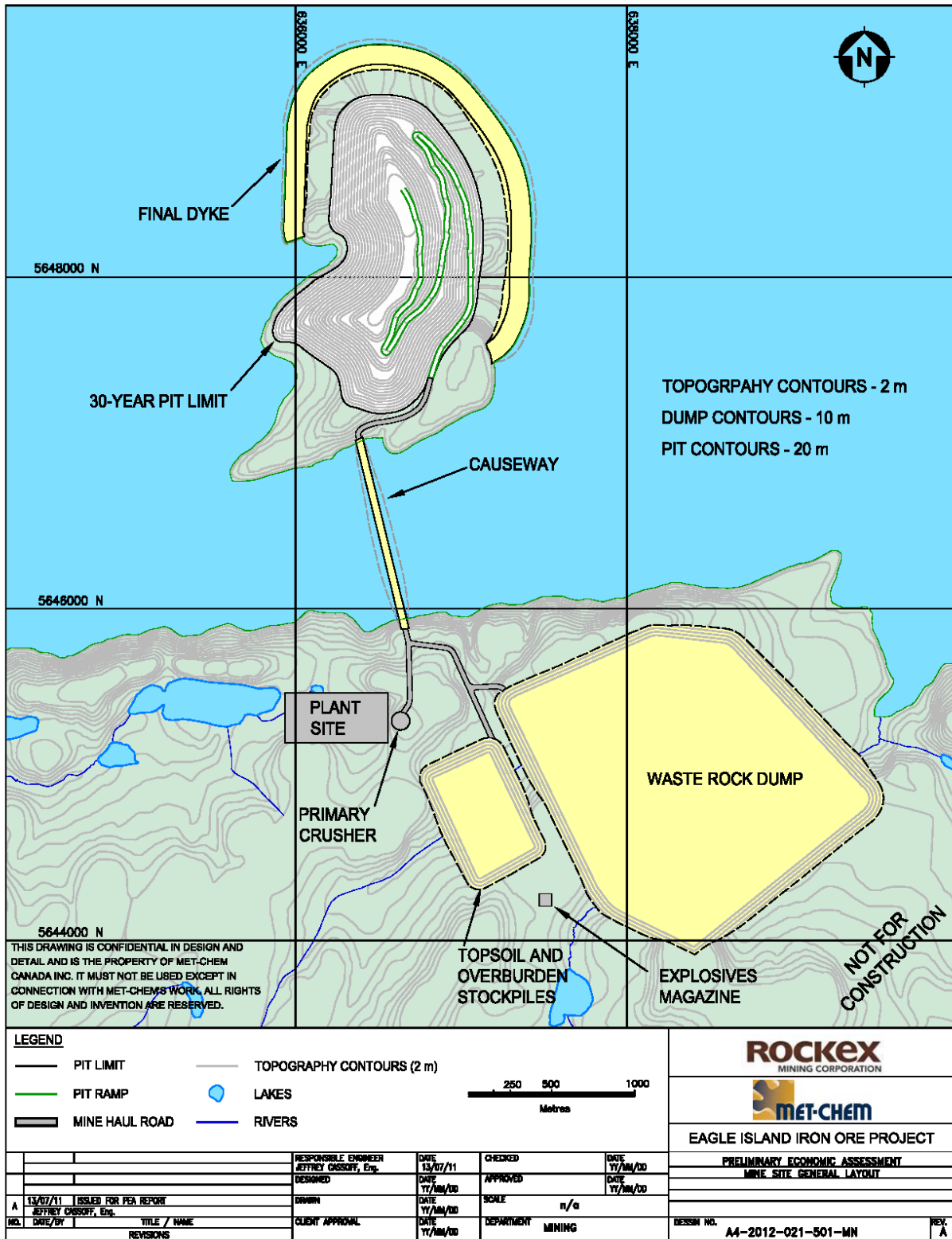
In order to access the pit, a 1.3 km long causeway will be constructed to connect the south shore of Lake St. Joseph to Eagle Island. A series of dykes will also be constructed to permit dewatering of the mineral resources that lie beneath the lake. The mine will operate year round, 365 days per year, 24 hours per day. The mine fleet requirements and manpower are based on this work schedule. Figure 16-1 provides a general layout of the mine. All of the pit design and mine planning work for this PEA was done using MineSight® Version 7.8. MineSight® is commercially available software that has been used by Met-Chem for the past 25 years.

16.1 Block Model

The 3-dimensional geological block model that was used to develop the mine plan was prepared by Met-Chem and was discussed in Section 14 of this Report. The block model is composed of blocks that are 50 m × 50 m × 10 m high. For each block containing mineralized material, the model includes the percentage of iron, the density as well as the resource classification (measured, indicated or inferred).

Using information supplied by Rockex, Met-Chem created a wireframe surface to represent the topography. This topographic surface accounts for the elevations at the bottom of the lake and on Eagle Island. Using data from the drill holes, Met-Chem created a wireframe surface to represent the contact between the overburden and bedrock. Overburden is defined as loose sand and gravels that can be excavated without the need for drilling and blasting.

Figure 16-1 – Mine General Layout



CIMA+ M03802A

16.2 Pit Optimization

Open pit optimization was conducted on the deposit to determine the pit shell that results in the highest Net Present Value (“NPV”) for the Project. A series of pit shells was generated using the Lerch Grossman algorithm in the Economic Planner optimizer of MineSight®. These shells were generated by varying the selling price.

The optimization was carried out during the initial stage of the Project using the cost, sales price and pit and plant operating parameters presented in Table 16-1. These parameters are preliminary estimates for developing the economic pit and should not be confused with the operating costs subsequently developed for the PEA and given in Section 21.6. All costs are stated in Canadian Dollars unless otherwise specified. The pit optimization was re-evaluated after a preliminary mine plan was completed and the cost, sales price and pit and plant operating parameters were better defined. The determination of the sales price for HBI of US\$ 350/t is presented in Section 19.

Since this Study is at a PEA level, NI 43-101 guidelines allow Inferred Mineral Resources to be used in the optimization and mine plan.

Table 16-1 – Pit Optimization Parameters*

Item	Value	Unit
Mining Cost	3.00	\$/t (mined)
Concentrator & Tailings Cost	6.50	\$/t (milled)
Pelletizing Cost	13.50	\$/t (concentrate)
Briquetting Cost	66.00	(\$/t pellet)
Transport Cost	0.30	\$/t (HBI)
General & Administration Cost	6.50	\$/t (HBI)
Sales Price (FOB Sioux Lookout)	350	US\$/t (HBI)
Concentrator Recovery	80	%
Concentrate Grade	66.3	%
Weight Recovery (Conc. To HBI)	71.3	%
Overall Pit Slope	48	Deg
Annual Production (HBI)	4.3	Mt
Discount Rate	10	%

CIMA+ M03802A



16.2.1 Pit Optimization Results

Table 16-2 presents the tonnages and grades that are associated with each of the 10 pit shells. The NPV was calculated for each shell based on the parameters presented in Table 16.1. Figure 16.2 is a chart showing the NPV vs. the mineralized tonnage for each shell.

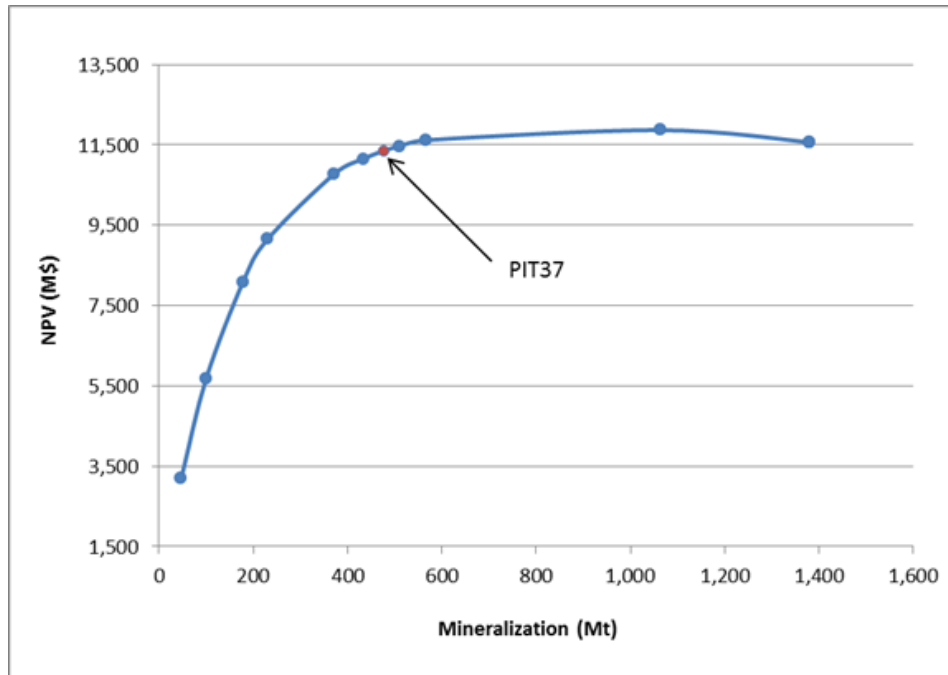
Table 16-2 – Pit Optimization Results

Pit Shell	Mineralization (Mt)	Fe (%)	Waste ¹ (Mt)	Strip Ratio	Mine Life (y)	NPV ² (\$M)
PIT31	48	33.4	4	0.09	4	3,206
PIT32	101	32.6	10	0.10	7	5,684
PIT33	179	31.8	17	0.09	12	8,085
PIT34	231	31.5	23	0.10	15	9,159
PIT35	372	30.7	48	0.13	23	10,782
PIT36	434	30.4	62	0.14	27	11,152
PIT37	477	30.4	78	0.16	29	11,351
PIT38	510	30.3	92	0.18	31	11,468
PIT39	566	30.1	116	0.20	35	11,618
PIT40	1,064	29.1	480	0.45	63	11,868
PIT41	1,379	28.6	1,386	1.01	79	11,569
PIT42	1,381	28.6	1,429	1.04	80	11,553

1 – The pit shells do not contain an access ramp therefore the waste quantity will increase once the pit design parameters are applied.

2 – The NPV is calculated strictly on operating costs and selling price. It does not account for the capital and sustaining costs.

Figure 16-2 – Pit Optimization Results



The pit optimization results show that the NPV for the Project does not increase much beyond PIT37. This pit shell contains 477 Mt of mineralization which results in roughly a 30-year mine life. The optimized pit shell does not account for mining dilution and does not include an access ramp. These items are discussed in the Mine Design Section of this Report. Upon completion of the PEA, Met-Chem confirmed that the pit optimization exercise was still valid using the updated cost estimate developed in the Study.

Figure 16-3 shows an isometric view of PIT37. Figure 16-4 presents a typical section through the deposit showing the 10 pit shells.

Figure 16-3 – Isometric View of PIT37

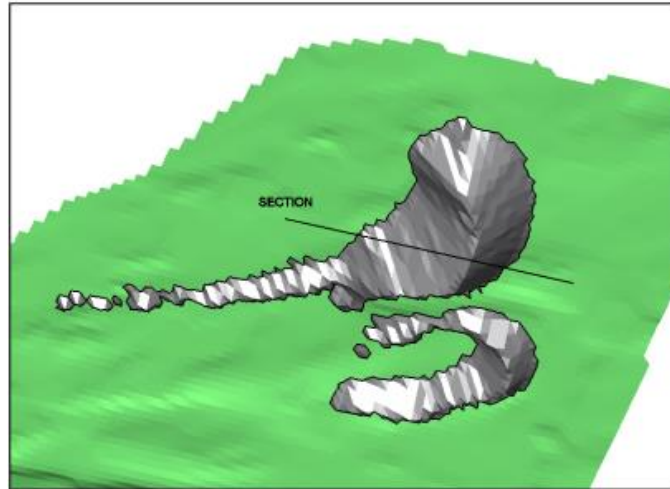
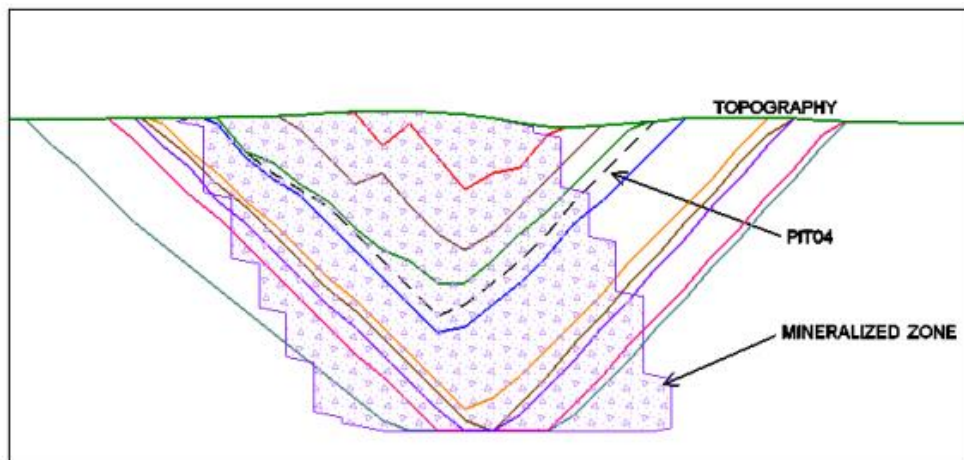


Figure 16-4 – Typical Section with Pit Shells



16.2.2 Cut-Off Grade

Using the economic parameters presented above, Met-Chem calculated a cut-off grade of 3.5% Fe for the Eagle Island Project. For the PEA it was decided to use a cut-off grade of 10% since there are very few tonnes below this level and it is more consistent with similar deposits. The cut-off grade is used to determine whether the material being mined will generate a profit after paying for the processing, transportation and G&A costs. Material that is mined below the cut-off grade is sent to the waste dump.

CIMA+ M03802A



16.3 Mine Design

Met-Chem designed a pit that followed PIT37 from the pit optimization and targeted a 30-year mine life for the Project at a production rate of 6 Mt of pellet feed per year. The following section provides the parameters that were used for the detailed pit design.

16.3.1 Material Properties

Table 16.3 defines the material properties used for the mine design and mine plan. The density for the mineralized material is a function of the Fe grade and was discussed in Section 14 of this Report. The remaining parameters such as the overburden and waste rock densities as well as the moisture content and swell factor were taken from Met-Chem’s internal database. These properties are important for determining the mine equipment fleet requirements.

Table 16-3 – Material Properties

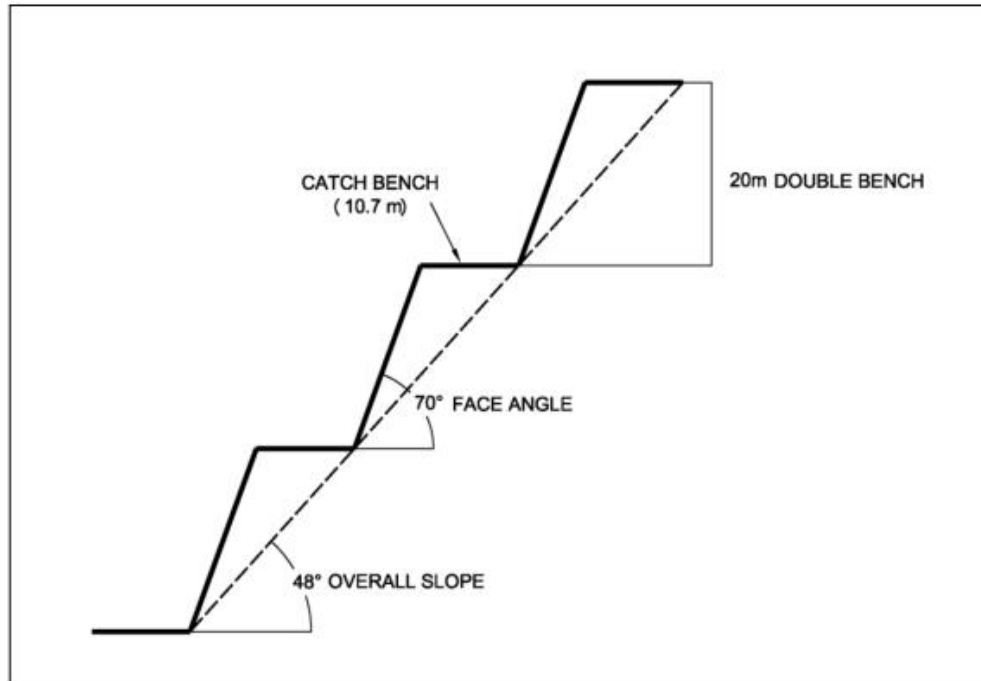
Material Type	In-Situ Dry Density (t/m ³)	Moisture Content (%)	Swell Factor (%)
Overburden	2.10	2	30
Waste	2.7	5	30
Mineralization	2.8 - 3.50	5	30

16.3.2 Geotechnical Pit Slope Parameters

Met-Chem used an overall pit slope of 48° for the final pit walls. The final pit wall includes a 10.7 m catch bench for every two (2), 10 m high benches and accounts for a 70° face angle. This design is based on Met-Chem’s internal database for similar deposits. Met-Chem recommends a complete pit slope analysis if the Project advances to the pre-feasibility stage. The pit wall configuration is illustrated in Figure 16-5. A minimum mining width of 50 m has been considered in the pit design.



Figure 16-5 – Pit Wall Configuration



16.3.3 Haul Road Design

The ramps and haul roads were designed with an overall width of 30 m. For double lane traffic, industry practice indicates the running surface width to be a minimum of three (3) times the width of the largest truck. The overall width of a 218 tonnes rigid frame haul truck is 8.3 m which results in a running surface of 25 m. The allowance for berms and ditches increases the overall haul road width to 30 m.

A maximum ramp grade of 10% was used. This grade is acceptable for a 218 tonnes rigid frame haul truck.

16.3.4 Lake Elevation

The current water level in Lake St. Joseph is 373 m (1,223 ft) above sea level. Since the water level of the lake is controlled at the Root River Dam, a letter provided by Ontario Hydro to the previous owner of the property, Algoma Steel, in 1969, states that the water level will not be raised above 375 m (1,230 ft).

The pit, dykes and causeway for the PEA were designed to an elevation of 377 m (1,236 ft) to account for a two (2) m buffer above the Ontario Hydro elevation.

CIMA+ M03802A

16.3.5 Causeway Design

A causeway will be constructed in order to access Eagle Island from the south shore of Lake St. Joseph. The causeway will be built during site development using waste rock from the pit area (equipment will be brought to the island with a barge) as well as from material excavated during the construction of the plant site. The causeway has been designed with a top width of 45 m and 34° side slopes (1.5H:1V). A minimum width of 45 m is required for a 218 tonnes haul truck to turn around and position to dump safely. The causeway does not require a cut-off wall to prevent seepage since it will not be used as a containment dyke.

The causeway that has been designed for the PEA is 1.3 km long. The causeway begins at the 390 m elevation on the mainland and includes a 5% ramp to reach the 377 m elevation. A total of 1.9 Mm³ of fill is required to build the causeway.

The causeway will be used to haul the mineralization from the pit to the primary crusher which will be located on the south shore. There is an opportunity in the next phase of the Project to evaluate the merits of relocating the primary crusher to the island. This will reduce the haul truck requirements. The crushed rock can then be transported over the causeway via a conveyor.

16.3.6 Dyke Design

In order to access enough mineral resources for the Project to be viable, a series of dykes will be constructed in the lake. The dyke concept and design are based on discussions between Met-Chem and Bauer Resources Canada Ltd. Bauer was involved in the construction of the A154 and A514 dykes at the Diavik diamond mine in the Northwest Territories. In the next phase of the Project, a geotechnical study should be carried out to confirm the assumptions used and to validate and optimize the dyke design. Due to the lack of geotechnical and hydrogeological information available at the time of this Study, Met-Chem does not guarantee the viability of the dyke design.

The first step in the dyke construction involves placing a silt curtain around the dyke perimeter. The silt curtain is used to prevent fine material that is generated during the construction operation to disseminate into the lake. Once the silt curtain is in place, the lake sediments within the footprint of the dyke will be removed with a dredging operation. This material which is estimated at an average thickness of three (3) m is removed to increase the geotechnical stability of the dyke. A one (1) m thick filter will be constructed on the downstream side of the dyke. This gravel filter is used to control any seepage that may propagate in the

dyke. Once the gravel filter is in place, the mining operation will supply run of mine waste rock to construct the outer shells of the dyke. The outer shells are both designed with a top width of 45 m to accommodate 218 tonnes haul trucks and will be built with 34° side slopes (1.5H:1V). A 10 m wide column between the two (2) outer shells will be filled with granular material. In order to minimize the volume required due to the 34° side slopes, the column of granular material will be built at the same pace as the outer shells. The central column of granular fill will be vibro-compacted in order to increase the consolidation.

Since the glacial till that lies below the footprint of the dyke does not provide the necessary friction to keep the dyke geotechnical stable, it will be removed and replaced with granular material by drilling 0.8 m diameter holes along the length of the dyke. These holes will be drilled with a rotary drill machine using a Kelly system. For this Study it was assumed that the depth of glacial till averages 8 m beneath the dyke.

Curtain grouting will be used in order to close natural fractures and joints in the bedrock. An assumption that curtain grouting will be required every 4.5 m has been used in this Study.

A 0.8 m wide concrete cut-off wall will then be placed in the center of the dyke using a cutter soil mixing machine. The cutter soil mixer injects concrete slurry into the granular column to create the cut-off wall which is designed to seal off any water leakage.

Jet grouting is then applied in order to close any remaining gaps between the bottom of the cut-off wall and the competent surface of the bedrock.

The cut-off wall will then be capped with 1.5 m of sand to prevent any freezing that may detriment the strength of the cut-off wall. The final step in the dyke construction is to relocate any fish from within the dyke to Lake St. Joseph and to pump out and clarify the water.

The toes of the dykes are designed to be a minimum 150 m from the crest of the pit. In order to delay the construction of the dykes, the pit will be mined in three (3) phases. Phase 1 is mined without the need for any dyking. Phase 2 requires a temporary dyke and Phase 3 requires the final dyke. Figure 16-6 shows a typical section through the dyke. Table 16-4 presents the quantities required to construct the dykes and causeway. The construction schedule is discussed in the mine planning section of this Report.

Although the design and location of the dykes ensure that the resources can be mined, there is room for optimization. This optimization can further reduce costs, timing and maximize resource recovery.

Figure 16-6 – Dyke Design

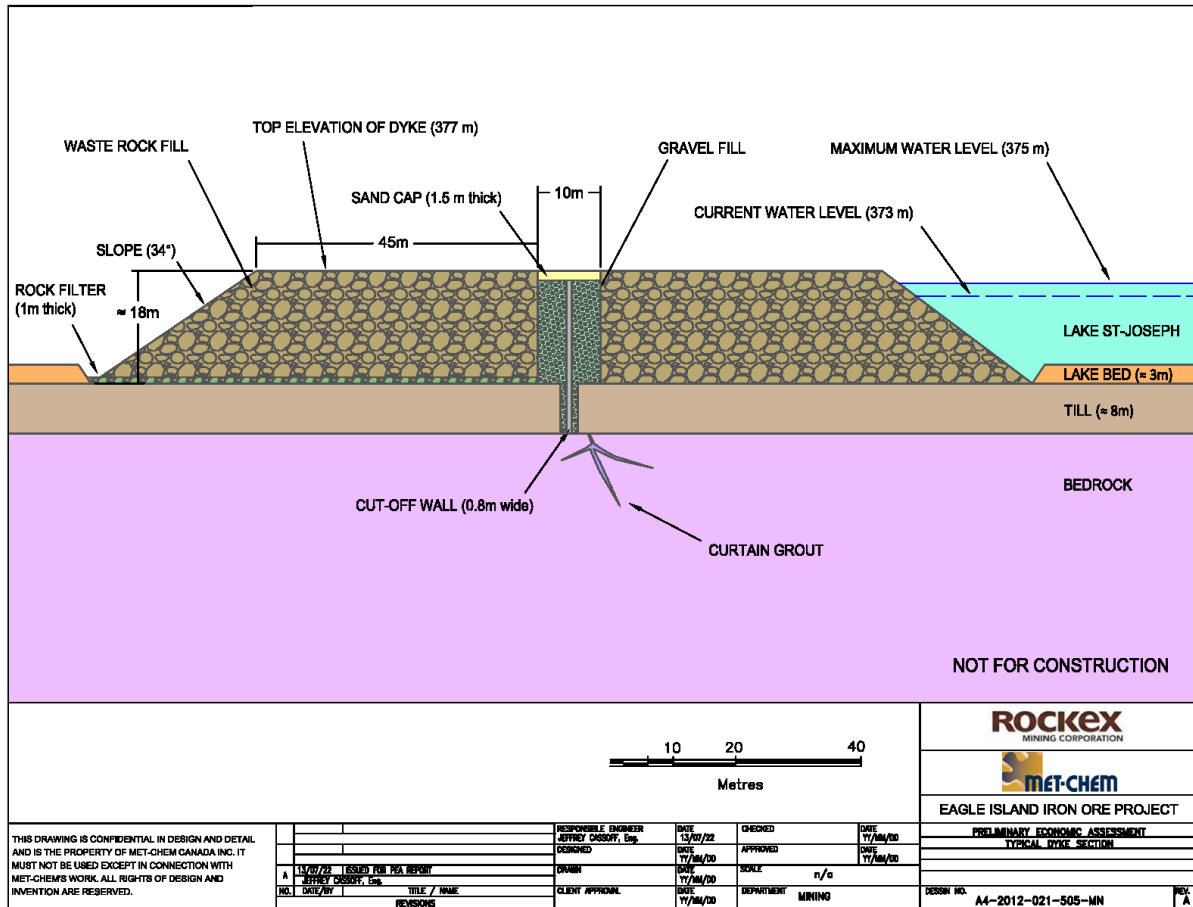


Table 16-4 – Dyke and Causeway Quantities

Description	Length (m)	Filter Rock (m ³)	Dredging (m ³)	Waste Rock (m ³)	Gravel Fill (m ³)	Sand Cap (m ³)	Water to Pump (m ³)	Average Height (m)
Causeway	1,265	n/a	n/a	1,900,000	n/a	n/a	n/a	21.6
Phase 2	1,000	50,000	435,000	2,080,000	200,000	15,000	3,800,000	12.7
Phase 3	3,700	185,000	1,662,000	8,844,000	960,000	55,500	16,500,000	16.5
Total	5,965	235,000	2,097,000	12,824,000	1,160,000	70,500	20,300,000	

16.3.7 Mine Dilution

During the mining operation, material at the mineralization and waste rock contacts will not be separated perfectly. A mining dilution factor of 5% at a grade of 0% Fe has been applied to account for this. The Fe

CIMA+ M03802A



grade of mineralized blocks in the model that neighbour waste blocks has been reduced to account for this dilution.

16.3.8 Pit Design

The pit design for the PEA followed the PIT37 pit shell from the pit optimization, targeting a 30-year mine life. In order to minimize the length of dykes required, the pit design concentrated on the north part of the deposit where the ore body is more massive. The southeast and southwest limbs were excluded from the pit design since a considerable amount of dyking is required to mine these resources.

The 30-year pit is approximately 2,000 m long and 900 m wide at surface with a maximum pit depth of 400 m. The total surface area of the pit is roughly 150 ha. The overburden thickness averages 8 m with a range of 0 m to 24 m.

The ramp accesses the pit at the 380 m elevation in the southeast corner. The ramp descends down the east wall and incorporates switchbacks at the 220 m and 80 m elevations. The lowest point in the pit is at the -20 m elevation.

The pit includes 512 Mt of Mineral Resources with an average Fe grade of 28.9% and has a strip ratio of 0.51:1. 26 Mt of overburden and 233 Mt of waste rock are included in the pit. Only 1.4% of the Mineral Resources contained within the pit are in the Inferred category.

As was discussed in the section on dyke design, the pit will be mined in three (3) phases. Phase 1 has been designed to maximize the resource without the need for dykes. The crest of the Phase 1 pit has been designed with a 25 m offset from the 377 m contour on the island. The Phase 1 design mines the resource 110 m deep to the 270 m elevation. Phase 1 contains 54 Mt of resources which can be mined for three (3) years at the planned production rate.

For Phase 2, a one (1) km long dyke is required on the east side of the island. The additional resources contained in the Phase 2 pit include 119 Mt which can be mined for six (6) years at the planned production rate.

For Phase 3, which mines to the 30-year pit limit, a 3.8 km dyke is required around the north end of the deposit. The additional resources contained in the Phase 3 pit include 339 Mt which can be mined for 21



years at the planned production rate. Table 16-5 presents the tonnages and grades for each phase. Figure 16-7, Figure 16-8 and Figure 16-9 are plan views showing the layout of the pit and dykes for each phase.

Table 16-5 – Tonnages and Grades by Phase

Description	Mineralization (Mt)	Fe Grade (%)	Overburden (Mt)	Waste Rock (Mt)	Total Waste (Mt)	Strip Ratio
Phase 1	54.0	27.4	3.4	18.0	21.4	0.40
Phase 2	119.2	26.3	4.5	56.6	61.1	0.51
Phase 3	338.8	30.1	17.7	158.4	176.1	0.52
Total	512	28.9	25.6	233	258.6	0.51

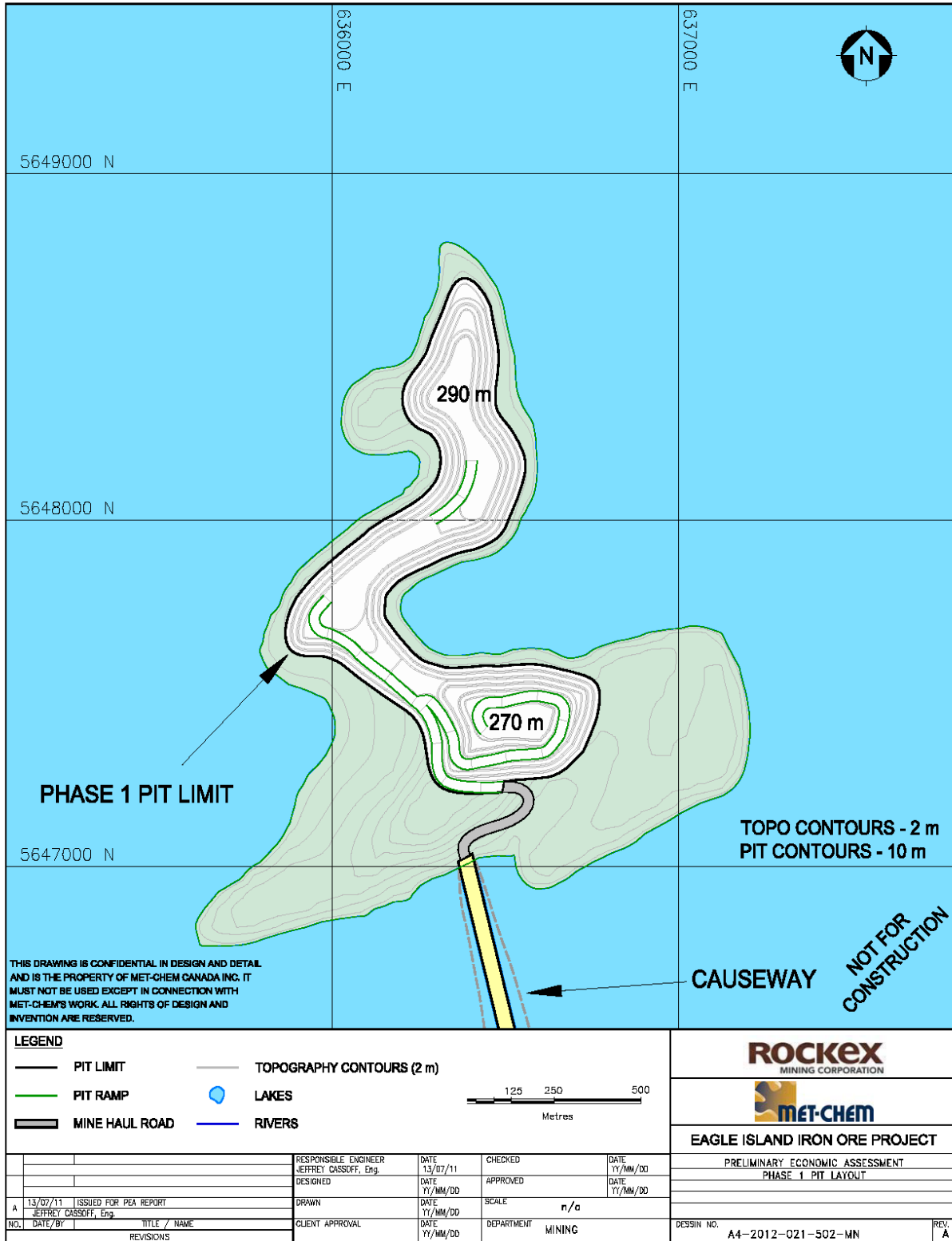
16.3.9 Dump Design

A waste rock dump was designed on the south shore of Lac St. Joseph to the east of the plant site. The waste dump was designed with an overall slope of 25° to account for the revegetation that is required with the closure plan. The dump has a capacity of 100 million m³, a top elevation of 430 m and a footprint area of 300 ha. The maximum height of the dump is 50 m.

An area of roughly 50 ha to the west of the waste rock dump has been dedicated for the topsoil and overburden stockpiles. The dump and stockpile layouts are shown on Figure 16-1.

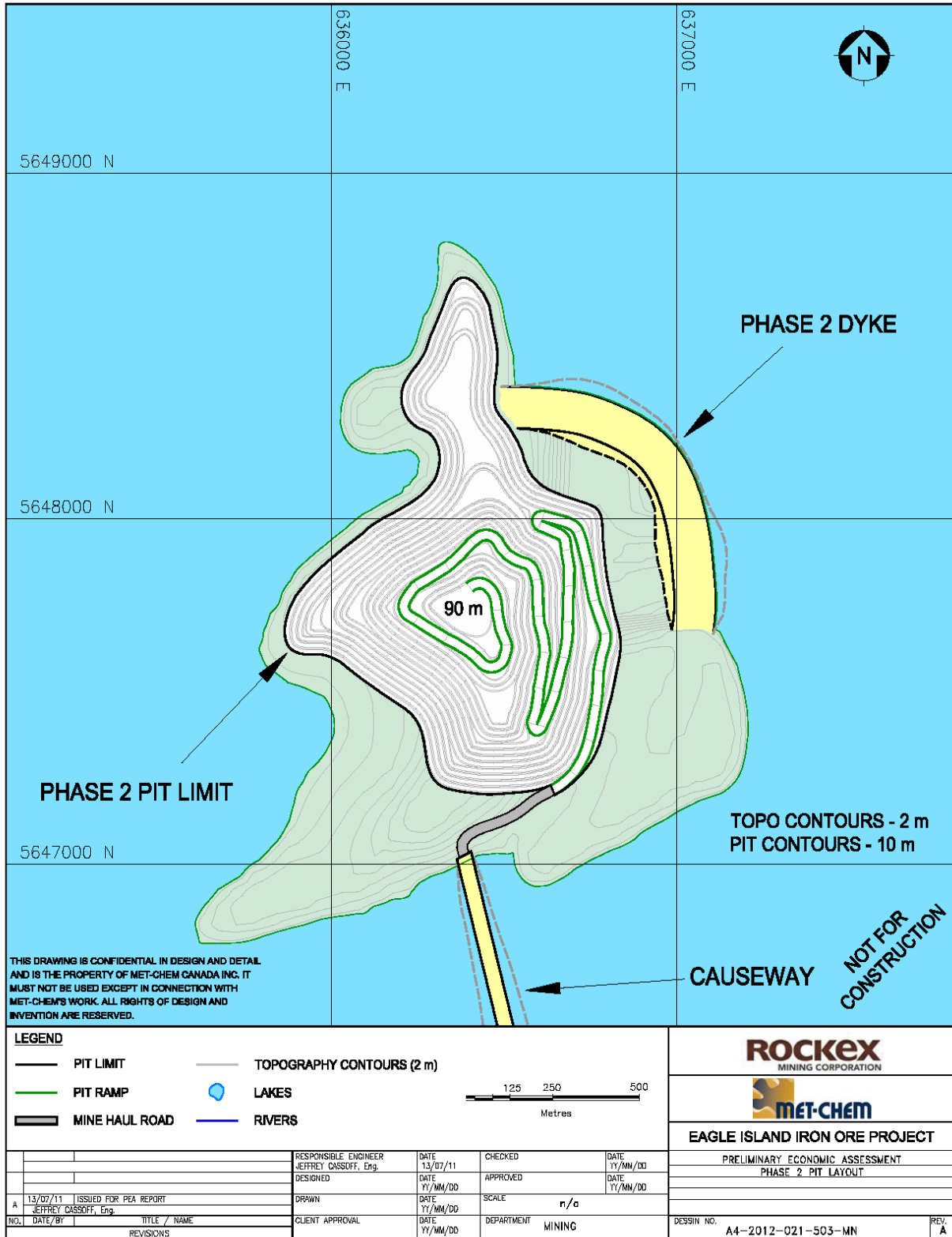


Figure 16-7 – Pit Layout (Phase 1)



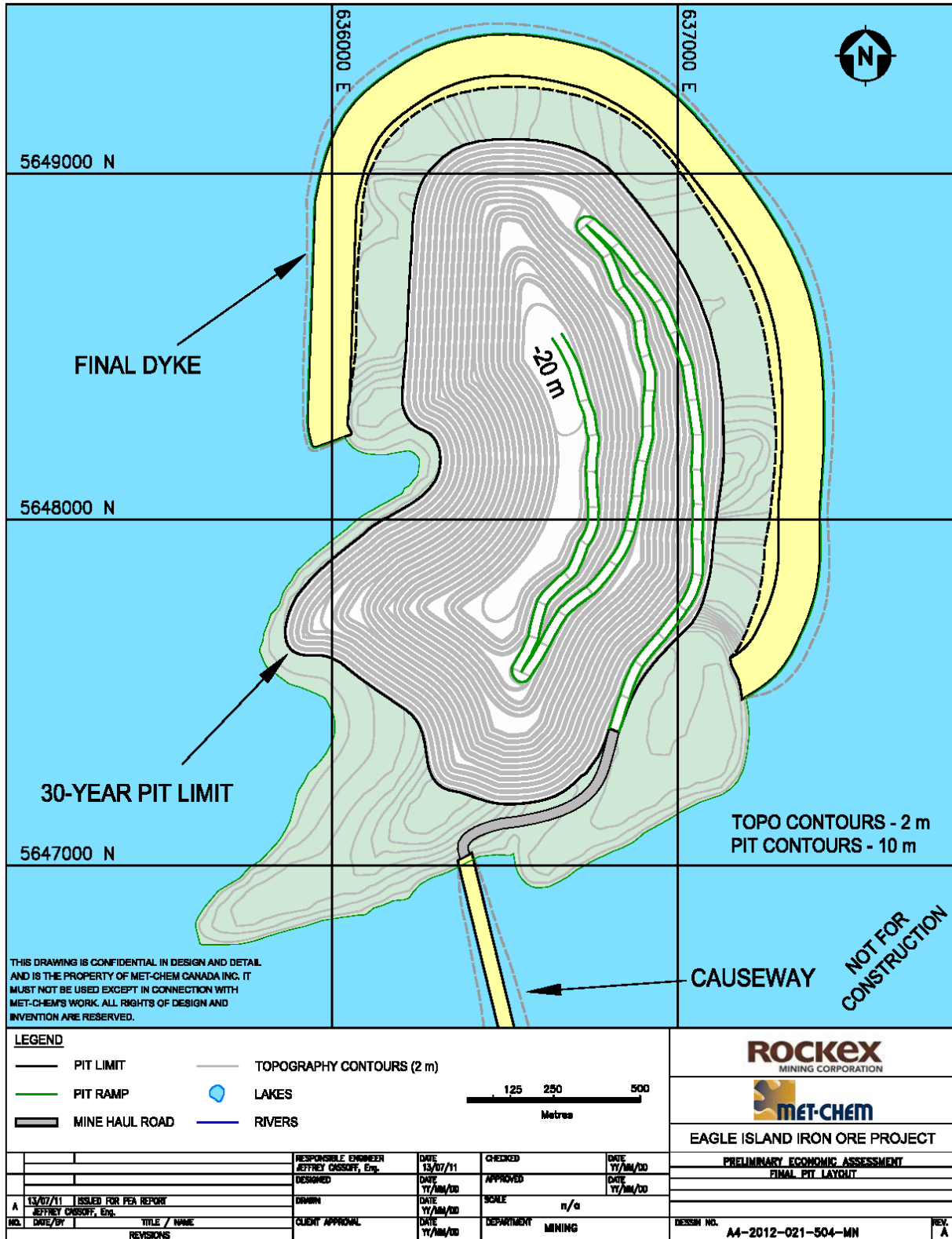
CIMA+ M03802A

Figure 16-8 – Pit Layout (Phase 2)



CIMA+ M03802A

Figure 16-9 – Pit Layout (Final Design)



CIMA+ M03802A

16.4 Mine Planning

A production schedule (mine plan) was developed for the Eagle Island Project to produce 6 Mt of iron pellet feed per year which will then be converted into 4.3 Mt of HBI. Using the mill recovery of 80% and a targeted pellet feed grade of 66.3% results in an average run of mine feed of 17.3 Mtpy at an average Fe grade of 28.9%.

A pre-production phase of one (1) year has been planned to achieve the following objectives:

- Clear vegetation and topsoil;
- Construct the causeway;
- Strip overburden and waste rock to expose the mineralization
- Stockpile 500,000 t of feed ahead of the crusher.

The mine production schedule was developed annually for the first five (5) years and in five (5) year blocks from Year 6 to 30.

The schedule produces 5.25 Mt of pellet feed in the first year of production which accounts for a plant ramp up of 75% capacity during the first six (6) months. Phase 1 is mined from the start of the operation until Year 3. The first dyke must be complete in the middle of Year 2 so that the area can be dewatered and the pit developed for mining to begin towards the end of Year 2. Mining in Phase 3 will begin in Year 9 so the final dyke must be in place in Year 8. Since the Phase 2 dyke falls within the limits of Phase 3, it must be mined out as rehandle. The Phase 2 dyke was not incorporated into Phase 3 to avoid having a weak spot at the junction of the two (2) dykes.

The mine production schedule is presented in Table 16-6.

Table 16-6 – Mine Production Schedule (in '000,000 t)

Description	Units	Pre Prod	Year 01	Year 02	Year 03	Year 04	Year 05	Year 6-10	Year 11-15	Year 16-20	Year 21-25	Year 26-30	Total
Pellet Feed	Mt	0.0	5.3	6.0	6.0	6.0	6.0	30.0	30.0	30.0	30.0	30.0	179.3
ROM to Plant	0	16.1	18.4	17.8	18.7	19.2	92.5	82.2	82.9	82.8	81.8	512.3	
Fe	%		27.1	27.1	27.9	26.6	25.9	26.9	30.3	30	30	30.4	28.9
Total Waste	Mt	5.4	6.6	8	6.5	8.2	11.3	64.8	52.8	44.6	32.8	23.3	264.2
Overburden	Mt	3.4	0.0	4.5	0.0	0.0	8.9	8.9	0.0	0.0	0.0	0.0	25.6
Waste Rock	Mt	2.0	6.6	3.6	6.5	8.2	2.4	50.2	52.8	44.6	32.8	23.3	233
Dyke Rehandle	Mt	0.0	0.0	0.0	0.0	0.0	0.0	5.7	0.0	0.0	0.0	0.0	5.7
Total Material Moved	Mt	5.4	22.6	26.4	24.3	26.9	30.5	157.3	135	127.5	115.6	105.2	776.5
Stripping Ratio ¹		n/a	0.4	0.4	0.4	0.4	0.6	0.6	0.6	0.5	0.4	0.3	0.5

1- The stripping ratio does not include the dyke rehandling.

16.5 Mine Equipment Fleet

The mine will be operated with an owner fleet with the exception of the overburden removal which will be carried out by a contractor. Table 16-7 presents the mine equipment fleet that is required for the Project during peak production. The table identifies the Caterpillar equivalent to give the reader an appreciation for the size of each machine. Fleet selection and requirements are discussed in this Section of the Report.

Table 16-7 – Mining Equipment Fleet

Equipment	Model	Description	Units
Major Equipment			
Haul Truck	CAT 793F	Payload – 218 t	14
Shovel	CAT 6060FS	Payload – 70 (26.5 m ³)	2
Production Drill	CAT MD6420	Hole Diameter – 251 mm	2
Support Equipment			
Utility Loader	CAT 994	Payload – 37 t	1
Track Dozer	CAT D10T	Power – 433 kW	3
Road Grader	CAT 160M	Power – 225 kW	2
Utility Backhoe	CAT 390D	Power – 390 kW	2
Water / Sand Truck	CAT 785	n/a	2
Secondary Drill	CAT MD5125	Hole Diameter – 165 mm	1
Lighting Plant	n/a	8 kW	8
Service Equipment			
Fuel and Lube Truck	n/a	n/a	2
Mechanic Truck	n/a	n/a	4
Tire Handler	n/a	n/a	1
Boom Truck	n/a	Capacity – 22 tonnes	2
Lowboy	n/a	Capacity – 150 tonnes	2
Mobile Crane	n/a	Capacity – 75 tonnes	1
Pick-up Truck	n/a	3/4 tonne	10
Transport Bus	n/a	20 seats	3

CIMA+ M03802A

16.5.1 Haul Trucks

The haul truck selected for the Project is a rigid frame haul truck with a nominal payload of 218 tonnes. This truck size was selected since it matches well with the production requirements and results in a manageable fleet size. The following parameters were used to calculate the number of trucks required to carry out the mine plan. These parameters result in 5,600 working hours per year for each truck.

- Mechanical Availability – 90%;
- Utilization – 90%;
- Nominal Payload – 218 tonnes (160 m³ heaped);
- Shift Schedule – Two (2), twelve (12) hour shift per day, seven (7) days per week;
- Operational Delays – 80 min/shift (this includes 15 minutes for shift change, 15 minutes for equipment inspection, 40 minutes for lunch and coffee breaks and 10 minutes for fuelling (fuelling is done once every 2 shifts for 20 minutes);
- Job Efficiency – 90% (54 min/h; this represents lost time due to queuing at the shovel and dump as well as interference along the haul routes);
- Rolling Resistance – 3%.

Haul routes were generated for each period of the mine plan to calculate the truck requirements. These haul routes were imported in Talpac[®], a commercially available truck simulation software package that Met-Chem has validated with mining operations. Talpac[®] calculated the travel time required for a 218 tonnes haul truck to complete each route.

Table 16-8 shows the various components of a truck's cycle time. The load time is calculated using a hydraulic shovel with a 26.5 m³ (70 tonnes) bucket as the loading unit. This shovel size which is discussed in the following section loads a 218 tonnes haul truck in four (4) passes.

Haul productivities (tonnes per work hour) were calculated for each haul route using the truck payload and cycle time. Table 16-9 shows the cycle time and productivity for the mineralization and waste haul routes in Year 5 as an example.

Table 16-8 – Truck Cycle Time

Activity	Duration (sec)
Spot @ Shovel	45
Load Time ¹	180
Travel Time	Calculated by Talpac [®]
Spot @ Dump	60
Dump Time	60

1. Four (4) Passes @ 45 sec/pass.

Table 16-9 – Truck Productivities (Year 5)

Material	Cycle Times (min)					Productivity	
	Travel	Spot	Load	Dump	Total	Load/h	t/h
Mineralization	22	0.75	3	1.5	27.5	2.18	476
Waste	25.5	0.75	3	1.5	30.5	1.97	429

16.5.2 Shovels

The main loading machine selected for the Project is a diesel powered hydraulic excavator with a 26.5 m³ (70 tonnes) bucket. This shovel size is a good match for a 218 tonnes haul truck and is a suitably sized shovel to handle the production requirements as well as the face heights expected.

During peak production, two (2) shovels are required to mine the tonnages presented in the mine plan. A large front end wheel loader capable of loading the 218 tonne trucks has been included in the fleet. This machine will be used as an alternate loading tool and will manage the stockpile rehandling.

16.5.3 Drilling and Blasting

The mineralized material and waste rock will be drilled and blasted. The blast pattern for the Project is presented in Table 16.10. Production drilling will be done using a diesel powered rotary drill with 251 mm (9-7/8 inch) diameter holes. Two (2) drills are required for the Project, assuming a 90% mechanical availability, a 90% utilization and a penetration rate of 25 m/h. During full production there will be roughly two (2) blasts per week each producing approximately 250,000 t.



Table 16.10 – Blasting Parameters

Parameter	Units	Value
Bench Height	m	10
Blasthole Diameter	mm	251
Burden	m	5.3
Spacing	m	6.1
Subdrilling	m	2.3
Stemming	m	4.9
Explosives Density	g/cm ³	1.25
Powder Factor	kg/t	0.36

Blasting will be carried out using bulk emulsion that will be transported to the mine by an explosives supplier. The blasts will be loaded and fired by the mine’s blaster. The blasting accessories such as detonators, boosters and cord will be stored in the explosives magazine. The location of the magazine is shown on Figure 16.1.

16.6 Mine Dewatering

For each phase of the mine design, a ditch will be established around the perimeter of the pit to intercept water before it infiltrates into the pit. Rain water and ground water that is collected in the pit will be collected in an in-pit sump and pumped to a settling pond at surface.

A ditch system will be established around the footprint of the waste dump and stockpiles. Water collected in these ditches will be directed to settling ponds. All water that is collected in the ditches and sumps will be treated and sampled prior to discharge into the environment.

Met-Chem recommends that a hydrogeological study be carried out if the Project advances to the pre-feasibility stage. This Study will provide an estimate of the quantity of water that is expected to be encountered during the mining operation.

16.7 Manpower Requirements

The mine workforce for the Project ranges from 104 employees in pre-production to 180 during full production. The mine employees will work on a 2 weeks on, 2 weeks off rotation. Table 16-11 summarizes the mine manpower requirements during peak production.

Table 16-11 – Mine Manpower Requirements

Description	# Employees
Supervision and Engineering	
Mine Superintendent	1
Maintenance Superintendent	1
Pit Foreman	4
Maintenance Foreman	4
Mining Engineer	4
Geologist	4
Surveyor	4
Mine Operations	
Truck Operator	56
Shovel Operator	8
Drill Operator	8
Dozer Operator	12
Grader Operator	8
Water Truck Operator	8
Mechanic	28
Tool Crib Attendant	4
Fuel / Lube Truck Driver	8
Blaster	2
Labourer	8
Utility Operator	8
Total Mine Workforce	180

CIMA+ M03802A



17 Recovery Methods

The process design and flow sheet development for the Rockex Project is based on the metallurgical test program performed at SGS and described in Section 13.0 of this Report.

Processing of the Rockex iron mineralization is based on production of an iron concentrate in a processing facility located at Lake St. Joseph, about 100 km NE of Sioux Lookout, and 350 km NW of Thunder Bay on Lake Superior in Ontario.

The iron in the ROM will be concentrated using gravity separation, magnetic separation and desliming. As determined by test results, the spiral separators will have a weight recovery of 15.3% while magnetic separators will recover 12.3% and the desliming will produce a further 7.0% for a total of 34.6% weight recovery. The process design is based on the results from metallurgical test work (see Section 13).

The ROM average production will be 17.3 Mtpy to yield 6.0 Mtpy of pellet feed at 66.3% Fe.

The pelleting and the briquetting plant will be located at Sioux-Lookout nearby the railroad.

Unless otherwise noted, all weight and throughput are in dry tonnes.

17.1 Process Plant

The processing plant flow sheet and design criteria (DC) is developed, based on the results from the metallurgical test program discussed in Section 13.0 of this Report.

The concentrator has been designed to produce an iron pellet feed grading 66.3% iron and 5.23% SiO₂ from an average feed containing 28.9% iron and 45.5% silica. The beneficiation processes includes crushing, grinding, screening, gravity and magnetic separation and desliming. The further processing includes pelletizing and Hot Briquetting to produce Hot Briquetted Iron (HBI) as final product.

A pipeline transports the pellet feed from the mine site to Sioux Lookout.

17.1.1 Process Design Criteria

The concentrator, Pellet plant and HBI plant facilities will operate for 24 hours per day, 7 days per week and 52 weeks per year at an expected 90% utilisation.

All throughput rates are based on the production of 6.0 Mtpy of concentrate (pellet feed), pellets and 4.3 Mtpy HBI. The concentrator weight recovery of 34.6% is an average figure based on the test work results and may vary depending on the mineralization composition.

Concentrator design capacity is based on an average operating rate of 52,752 tpd, or a nominal throughput rate of 2,198 tph of iron material. The slurry pipeline will operate at a nominal throughput rate of 761 tph of iron pellet feed.

A detailed process design criteria has been developed for the purposes of the PEA. A summary of the design basis for the crusher, concentrator and the shipping facilities is presented in Table 17-1.

Table 17-1 – Process Design Basis

Parameter	Unit	Value
Total ROM Processing Rate	Mtpy	17.3
Crusher Operating Time	%	65
Nominal Crushing Rate	t/h	3,044
Concentrator Operating Time	%	90
Nominal Processing Rate	t/h	2,198
Shipping Facility Operating Time	%	90
Nominal Concentrate (Pellet Feed) Production Rate	t/h	761
Total Weight Recovery	%	34.6
Spiral Separation Iron Concentrate Production	Mtpy	2.66
Magnetic Separation Iron Concentrate Production	Mtpy	2.13
Desliming Concentrate Production	Mtpy	1.21
Total Iron Concentrate (Pellet Feed) Production	Mtpy	6.00
Total Iron Pellets Production	Mtpy	6.00
Total HBI Production	Mtpy	4.30

CIMA+ M03802A

17.1.2 Flow Sheets and Process Description

Simplified flow sheets for the concentrator is shown in Figure 17-1. The process is described in detail in the following sub-sections.

17.1.2.1 Crushing and Stockpiling

Run of mine, containing 28.9% iron, 45.5% silica and 5% moisture, is dumped directly into a gyratory crusher by the mine haul trucks. The crusher discharge product has a particle size of 80% less (P_{80}) than 175 mm. The conical crushed material stockpile has a total capacity of approximately 74,000 tonnes and a live capacity of about 30,000 tonnes. The feed is reclaimed by two (2) conveyors, each with three (3) apron feeders. The conveyors discharge onto the SAG mill feed conveyor.

17.1.2.2 Primary Grinding and Classification Circuit

The SAG mill will operate at a pulp density of 65% solids by mass in a closed circuit with two (2) vibrating screens. The screens oversize is conveyed to a diverter, located along the SAG mill feed conveyor, where a part is diverted to feed the pebble mill next to the SAG mill. The majority of the SAG circulating load is returned to the SAG mill feed conveyor along with fresh grinding media. The screen undersize product will have a particle size P_{80} of 1,700 μm that will be pumped to the secondary grinding circuit.

17.1.2.3 Secondary Grinding and Gravity Separation

The SAG mill screen undersize will be pumped to three (3) parallel closed-loop ball mill circuits. The slurry is pre-classified via cyclones, with the cyclone underflow, i.e. the coarse material, reporting to the secondary grinding ball mills. The cyclone overflows are pumped to gravity separation circuits for silica removal.

The cyclone overflow of each ball mill circuit has a P_{80} of 88 μm and is pumped to three (3) gravity separation circuits each composed of two (2) stages of spiral gravity separators, rougher and cleaner. The rougher concentrate will be fed by gravity to the cleaner spirals located directly underneath. The rougher tails are final tails and are pumped to the tailings thickener. The cleaner concentrate is a final concentrate. It is about 44.3% of the total concentrate and has a target grade of 66.5% iron and about 5.0% silica and is pumped to the concentrate thickener and pipeline feed circuit. The cleaner tailings, containing 25.1% iron and 50.5% silica are pumped to the tertiary grinding circuits prior to further beneficiation.

For each of the three (3) ball mill lines, the rougher spirals are grouped in 21 banks of 10 double start spirals for a total of 420 rougher spirals per line or 1,260 for the three (3) rougher circuits. Each cleaner spiral bank is located directly under the corresponding rougher bank but is composed of only eight (8) double start per bank on account of the reduction in tonnage due to the rejection of tails.

17.1.2.4 Tertiary Grinding and Magnetic Separation Circuit

The cleaner spiral tails contain magnetite particles that are associated with silica. In order to liberate the particles, the cleaner spiral tails are directed to two (2) tertiary ball discharge pump boxes for further classification via cyclones and regrinding. The cyclone underflows are returned to the two (2) mills while the overflows, with particle size of P_{80} of 27 microns, are directed to 14 rougher LIMS (1.2 m by 3.8 m). The rougher tails are pumped to 12 single drum cleaner magnetic separators for further recovery of iron units.

The rougher and cleaner concentrates are piped to the finisher ball mill where they are mixed with the mill discharge and are pumped to a cyclone cluster. As a final liberation step, the cyclone underflow is reground in the finisher ball mill in closed circuit with cyclone. The cyclone overflow, with a size (P_{80}) of 18 microns, is further concentrated by three (3) double drum finisher LIMS and is pumped to a desliming thickener. The magnetite concentrate from desliming thickener underflow is a final concentrate and is pumped to the final concentrate thickener. The magnetic separation concentrate represents about 35.5% of the total concentrate and will have an average grade of 66.9% Fe and 5.2% silica.

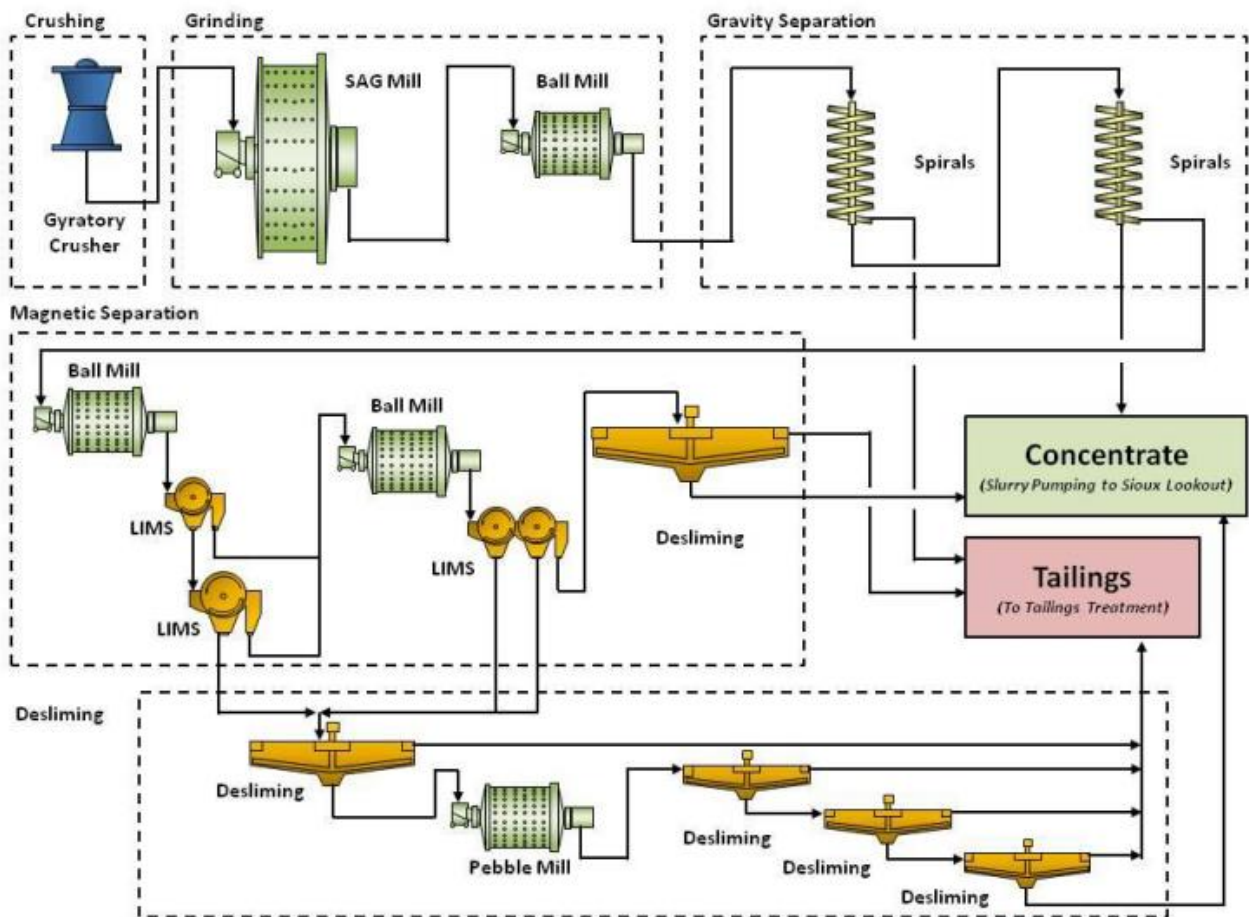
17.1.2.5 Final Desliming

The cleaner and finisher LIMS tails contains unliberated iron oxides. The slurry is conditioned and fed to the primary desliming thickener which separates liberated silicates from the iron oxides via differential settling rates. The silicates, otherwise known as the “slimes”, report to the thickener overflow and are pumped to final tailings, while the denser iron oxides settle out and report to the thickener underflow. The underflow is fed to closed circuit pebble mill. The pebble mill further liberates silicates from the iron oxide particles. The cyclone overflow has a P_{80} of 18 microns and reports to the final three (3) desliming thickeners. Each stage removes further “slimes” which further upgrades the iron oxides which reports to the underflow. The concentrate is pumped to the final concentrate thickener. The desliming circuit concentrate will represent 20.2% of the total concentrate and will have a grade of 64.9% Fe and 5.81% silica.

17.1.2.6 Final Tailings Circuit

The final tailings consist of the combined spirals, magnetic and desliming tails. These are thickened to 50% solids and pumped to the tailings pond located south of the concentrator building. About 80% of the water in the thickened tailings slurry is returned as reclaimed water to the plant. The remaining water is trapped in the tailing or is lost via either evaporation or percolation. The thickener overflow is pumped to the process water tanks. The final tailings have a 8.8% iron and 66.8% silica grade respectfully.

Figure 17-1 – Simplified Concentrator Flow Sheet



17.1.2.7 Pellet Feed Storage and Reclamation and Car Loading

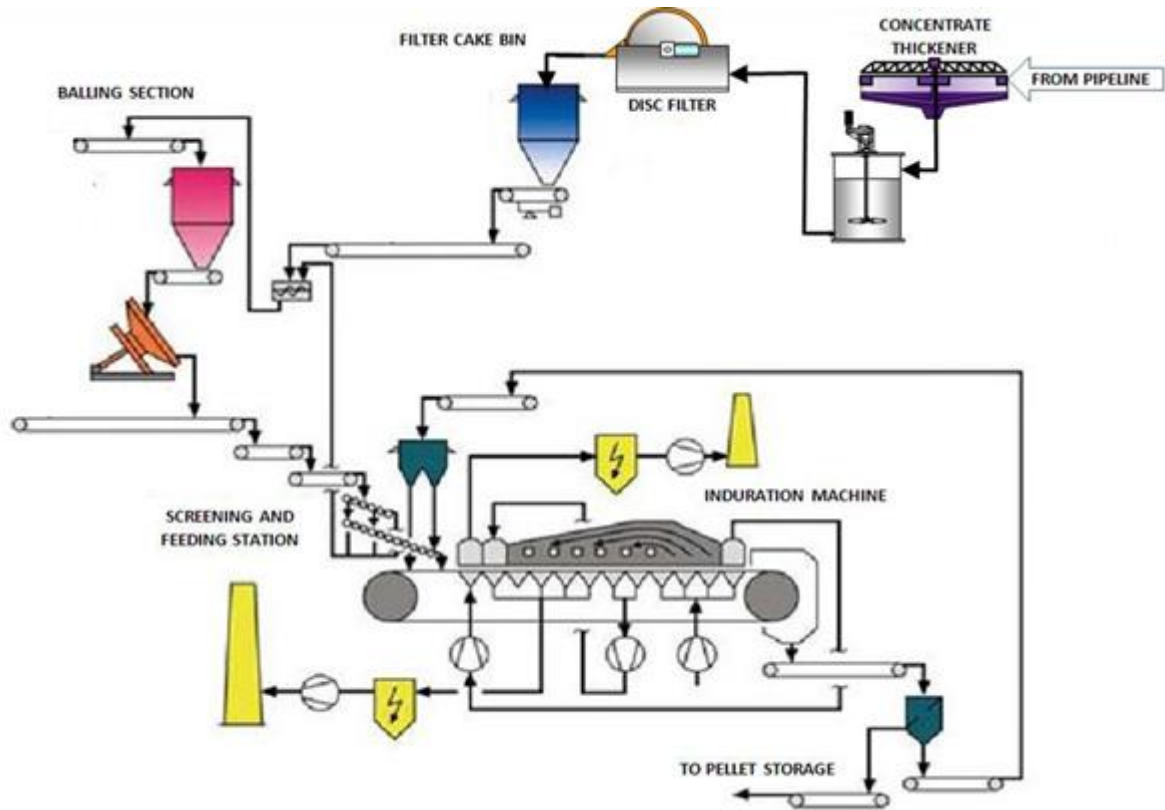
An overhead tripper conveyor creates a pellet feed stockpile of 60,000 tonnes representing slightly over three (3) days of nominal operation. This will be stored in a covered facility. The pellet feed is reclaimed using a 3,000 tph drum type reclaimer. The reclaim pellet feed is transported to the Pellet Plant.

CIMA+ M03802A



Figure 17-2 shows a simplified flow sheet of the Sioux Lookout Pellet Plant facilities.

Figure 17-2 – Simplified Flow Sheet for Sioux Lookout Facility



17.1.2.8 Pellet Plant

17.1.2.8.1 Bentonite Grinding

Bentonite will be used as the pelletizing binder. Bentonite will be reclaimed from a bentonite storage facility and charged to a storage bin in the grinding building. It will be withdrawn by belt feeder and fed to a vertical roller mill. Material which has passed between the mill rolls is lifted in a stream of air. A dynamic separator within the mill returns coarse particles directly to the mill. Finer particles are lifted out of the mill in a gas stream and are collected by a cyclone and bag filter and discharged through rotary valves into an aerated storage silo. Part of the cleaned air is returned to the mill. The bentonite will be pneumatically transported to bins in the mixer area of the 6 Mtpy pellet plant.

CIMA+ M03802A



17.1.2.8.2 Flux Grinding

Based on the needs and requirements, limestone will be ground to pelletizing fineness in a wet ball mill in closed circuit with hydrocyclones. This flux will be reclaimed from limestone stockpile and conveyed to a storage bin. The flux will be withdrawn from the bin by feeder and fed into a ball mill with an installed power of 2,600kW. Water will be added to give an in-mill density of 75% of solids by weight.

Ball mill discharge is collected in a pump box, diluted to approximately 50% solids and pumped to a hydrocyclone cluster. Coarse underflow is returned to the feed of the mill, while the overflow is pumped to the flux agitated storage tank. Limestone slurry is pumped from the storage tank to the induration machine discharge conveyor by variable speed pump. One flux grinding facility will serve both pellet plants.

17.1.2.8.3 Concentrate Slurry Reception and Storage

The concentrate slurry will be received at the pellet plant at approximately 65% by weight of solids from a pipeline. The slurry will be fed directly to the slurry tank. The slurry tank have a total maximum storage of 8 hours. Steam will be injected into the slurry storage tank to maintain slurry temperature at approximately 45°C. The concentrate is then pumped to a filter line at a measured rate.

17.1.2.8.4 Filtering

The concentrate is pumped to a pressure distributor and dewatered in six (6) vacuum disc filters (and a seventh filter on standby). Six (6) vacuum pumps will be provided. Three (3) snap blow compressors, also common to all filters, will provide air for cake release. The filter cake is transferred via conveyor to the filter cake bins in the mixing station. Filtrate and filter boot drain is pumped back to the thickener. Distributor and filter boot overflow slurry is returned by gravity to the filter feed tank.

17.1.2.8.5 Mixing

The bentonite will be fed to the mixer feed by a screw feeder. Concentrate is withdrawn from cake bins by feeders and discharged into the mixer. The filter cake and binder are mixed in a horizontal mixer. A spare mixer is provided in case of break down. The mixed material will be transported by belt conveyor to the balling area. Reject green balls from the green ball screening system will be added to the mixed material downstream of the mixer.

17.1.2.8.6 Balling

A conveyor distributes the mixed material and green ball returns into nine balling discs feed bins. The mixed material will be continuously discharged from the balling feed bins and fed into nine balling discs. Each disc discharges on individual belt conveyors that discharge onto a common collecting conveyor, which distributes the green pellet across a wide belt. The wide belt feeds onto a double deck roller screen whose function is to remove oversize and undersize. Green pellet fines will be recycled together with crushed oversize to the mixed material stream on the route between the mixer and the balling feed bins.

17.1.2.8.7 Induration

The pellets will be hardened on Straight Grate Induration machine. Green pellets will be dried in two stages. The dried pellets will be preheated to a progressively higher temperature to calcine the flux and to initiate magnetite oxidation. The pellets will then be fired at approx. 1,270°C to provide the recrystallization and slag bonding which will give the pellets adequate strength. A short section designated as after-firing allows the heat front to completely penetrate to the bottom of the bed without the application of additional high temperature heat. Cooling is accomplished in two stages by passage of ambient air supplied by a cooling air fan. The cooled pellets leave the induration machine at 100°C or less.

Five process fans provide process gas flow. The cooling air fan forces ambient air through the pellet bed. In the first cooling section, the air leaving the top of the bed, which contains a large amount of sensible heat from the cooling operation, is ducted through a direct recuperation header, without the use of a hot fan. Process gas from the second cooling stage is transported by the updraft-drying fan to the updraft drying section of the grate.

17.1.2.8.8 Pellet Loadout and Product Handling

Product pellets discharged from the segregation bin will be transported by conveyor to the pellet stockyard.

The estimated stockpile area has 2 stockpiles for a total size of 150 m x 1,200 m, to handle production of 6 Mtpy and storage. Pellet products will be reclaimed by a slewing type bucket reclaimer. The reclaimed iron pellet products will be transported from the stockpile to the car loader by a conveyor system operating at 3,000 tph.

17.1.2.8.9 Recycling Hearth and Side-Layer

Pellets discharged from each induration machine will be transported to a natural segregation bin. Larger pellets will segregate to the sides of the bin and will be allowed to overflow a side chute to return as hearth layer. Tramp material and agglomerates are prevented from being recycled in the hearth layer by the use of a static grizzly screen. The product pellets will be discharged from the bottom of the bin.

17.1.2.8.10 Induration Area Dust Collection

Process gas from the hood exhaust and windbox exhaust systems are cleaned for particulate matter by dry electrostatic precipitators. The dust collected will be slurried with water and pumped to the waste reclaim area.

17.1.2.8.11 Waste Reclamation

Dust from the electrostatic precipitators will be slurried with process water and collected together with slurry from scrubbers and washdown and is pumped to the thickeners. Thickener underflow is then sent to the filter feed tanks and thus all waste materials are returned to the process. Thickener overflow is returned to the process water tank.

17.1.2.8.12 Auxiliary Systems and Infrastructure for the Pellet Plant

- Natural gas - The Induration process, the pilot burners and the air heater of the bentonite grinding system will operate with natural gas.
- Steam System - Steam is required for fuel oil and slurry heating as well as building heating.
- Water System - Water systems are provided for machinery cooling, gland & spray water, process water system and fire-fighting.
- Compressed Air Plant - A centralised system for the generation of plant compressed air and instrument air will be provided.

17.1.2.9 Hot Briquetted Iron (HBI) Plant

The Rockex HBI Plant will utilise gas-based direct reduction processes and will have capacity of 4.3Mtpa at an expected metalization of 94% Fe. The Pellet product is fed to a shaft-based reduction furnaces. The feedstock is prepared to adjust the size to the required in the reduction furnace. This requires screening for separation to adjust the particle size downward.

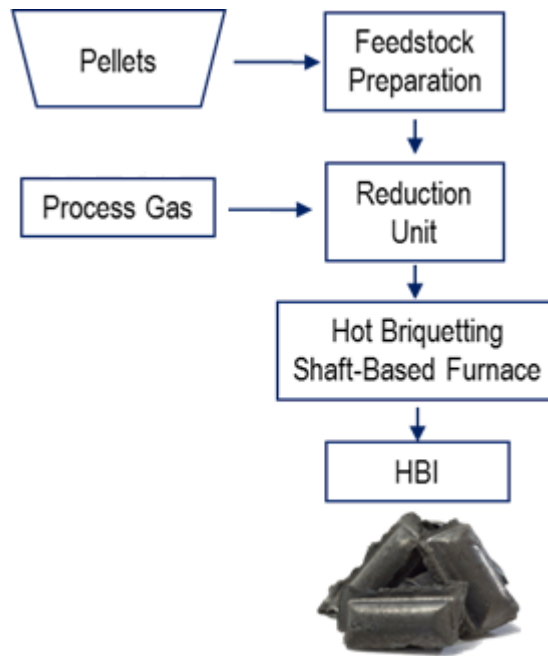
The process gas is formed to generate H₂ and CO to remove the oxygen from the ore. Coal is also added to the process gas to actuate in the reduction. Natural gas enters the reduction furnaces and is heated to the required temperature for reduction of the oxide feed.

Once reduced, the product is hot briquetted to produce the HBI (hot briquetted iron) and then cooled prior to storage in piles. The hot briquetting is performed in a shaft-based furnace, where the pellets product is introduced through a proportioning hopper at the top of the shaft furnace. As the ore descends through the furnace by gravity flow, it is heated and the oxygen is removed from the iron (reduced) by counter flowing gases, which have a high H₂ and CO content. With a screw the hot feed is pushed into the nip between two counter rotating rollers of the briquetting machine. Pockets in the synchronously rotating rollers form the briquettes. This process occurs at high temperatures (700°C) and high pressing forces (120 kN per cm active roller width). The continuous string of briquettes leaving the rollers is guided by a heavy chute and is separated into mostly singles for example by a rotor with impact bars. Briquettes from fine material, produced in fluidized bed processes, may also be separated in a rotating tumbling drum.

The entire plant for the hot briquetting consists of:

- Briquetting press with screw feeder and material supply
- Briquette string separator (impact separator or tumbling drum);
- Hot screen for the elimination of fines which occur during briquetting and separation
- Product cooler
- Bucket elevator for the recirculation of fines to the briquetting press
- Chutes and accessories

Figure 17-3 – Hot Briquetting Process for Sioux Lookout HBI Plant Facility



The final product is stockpiled and after reclaiming will be transported from the stockpile to the car loader by a conveyor system operating at 3,000 tph. The reclaimed HBI product is loaded in a unit train of 90 cars of 100 tonnes capacity each.

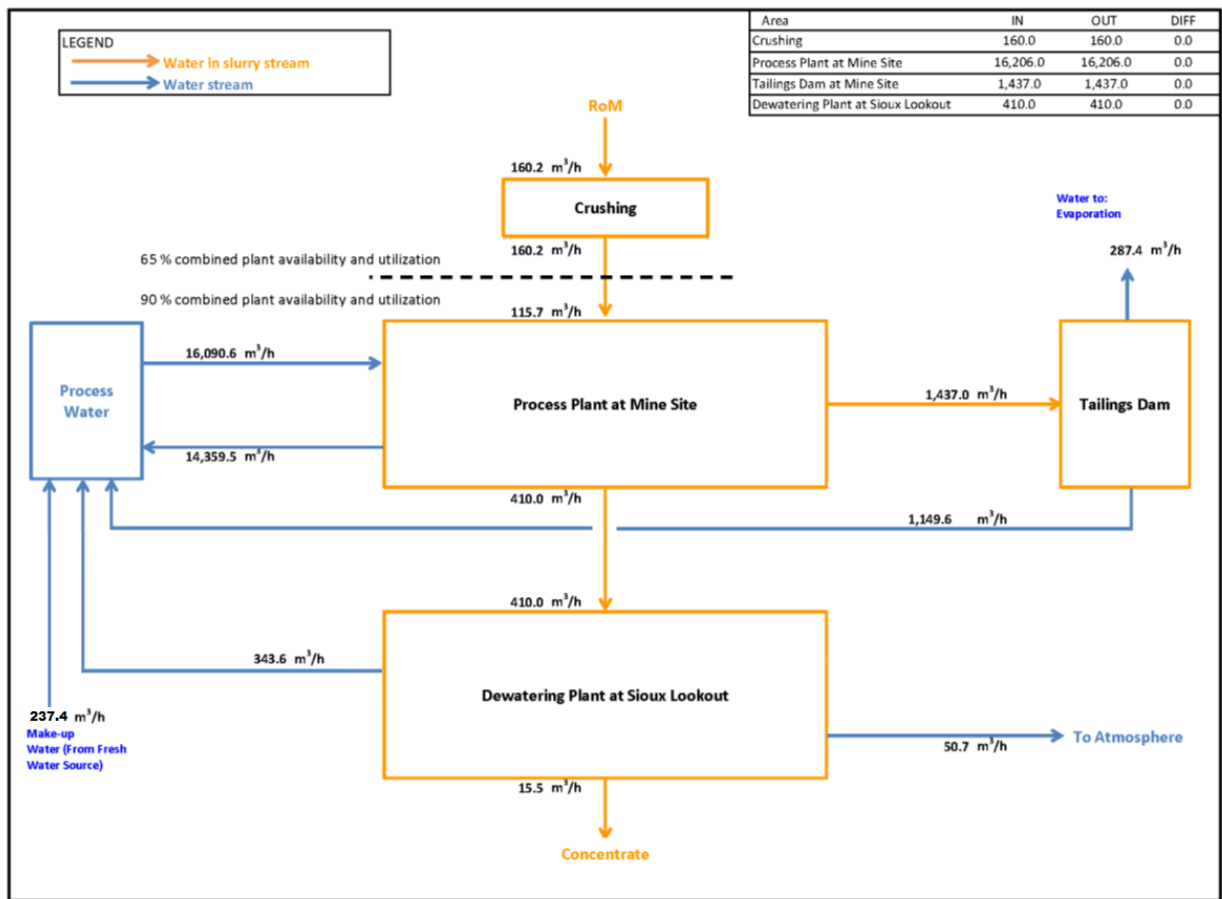
17.1.3 Mass Balance and Water Balance

The process plant mass balance has been calculated based on the developed flow sheet and the process design criteria. Table 17-2 summarizes the process mass balance and Figure 17.4 shows the simplified process water balance.

Table 17-2 – Summary Process Mass Balance

Mass Entering System				Mass Exiting System			
Streams	Dry Solids (t/h)	Water (m ³ /h)	Total Mass (wet t/h)	Streams	Dry Solids (t/h)	Water (m ³ /h)	Total Mass (wet t/h)
ROM to Concentrator	2,198	115.7	2,313.7	Evaporation from Dryers	—	50.7	50.7
Fresh Water	—	581.5	581.5	Final Pellet Feed	761	15.5	776.5
Reclaim Water from Tailings Pond	—	1,149.6	1,149.6	Final Tailings	1,437	1,780.6	3,217.6
Total Entering	2,198	1,846.8	4,044.8	Total Exiting	2,198	1,846.8	4,044.8

Figure 17-4– Water Balance



17.1.4 Equipment Sizing and Selection

The equipment selection was based on the design criteria and the design factor applied for most pieces of equipment was 15%.

CIMA+ M03802A

17.1.5 Utilities

17.1.5.1 Concentrator Water Services

The estimated water consumption is based on the nominal concentrator plant mass and water balance.

- **Fresh water:** Lake St. Joseph will be the main water source of fresh water near the concentrator. The nominal fresh water requirement is 581 m³/h.
- **Process water:** Reclaim water is recycled back from the tailing pond, at a nominal rate of 1,150 m³/h, using a vertical pump on a barge. The remainder of the process water demand (14,360 m³/h) comes from the overflow of the concentrate and the tailings thickeners.
- **Gland water:** The gland water system uses fresh water and has a separate water tank.

17.1.5.2 Concentrator Compressed Air

A compressor will supply the concentrator plant with 1,724 cfm of compressed air. An air dryer will be used for instrument air only. The crusher complex has its own compressed air system.

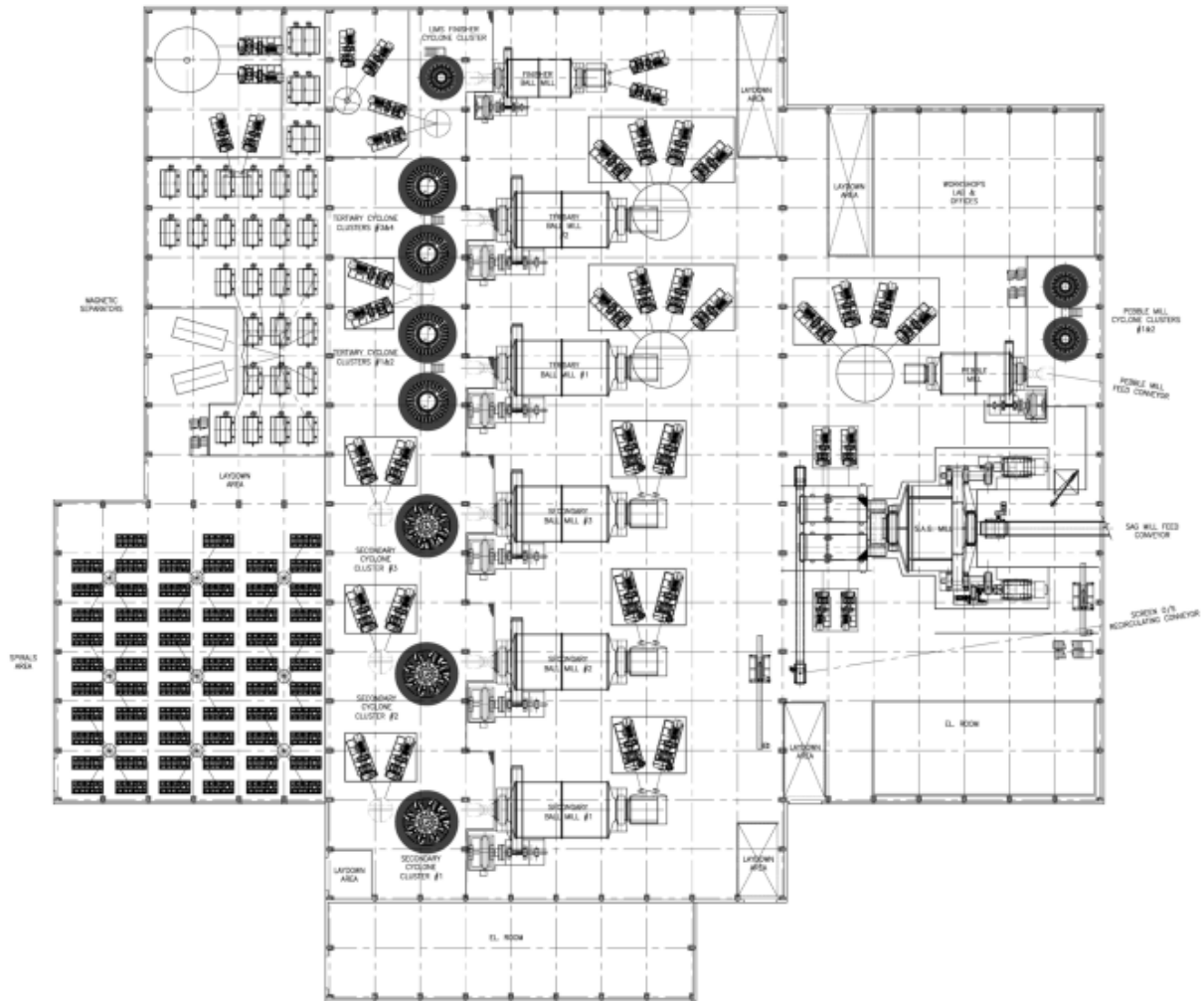
17.1.6 Power Requirements of Concentrator Plant and Sioux Lookout

The power requirement for the 6 Mtpy capacity plant is estimated at 180 MW. This includes only the 75 MW for the concentrator process areas, 100MW for the Pellet and HBI plants and the 4.8 MW for Sioux Lookout area. More power is required (16.6 MW) the infrastructure (heat, ventilation and services) and losses through main sub-station equipment and power lines.

17.1.7 Layouts

General arrangement drawings for the concentrator, has been developed by Met-Chem and is shown in Figure 17-5.

Figure 17-5 – Concentrator General Arrangement, Plan View



CIMA+ M03802A



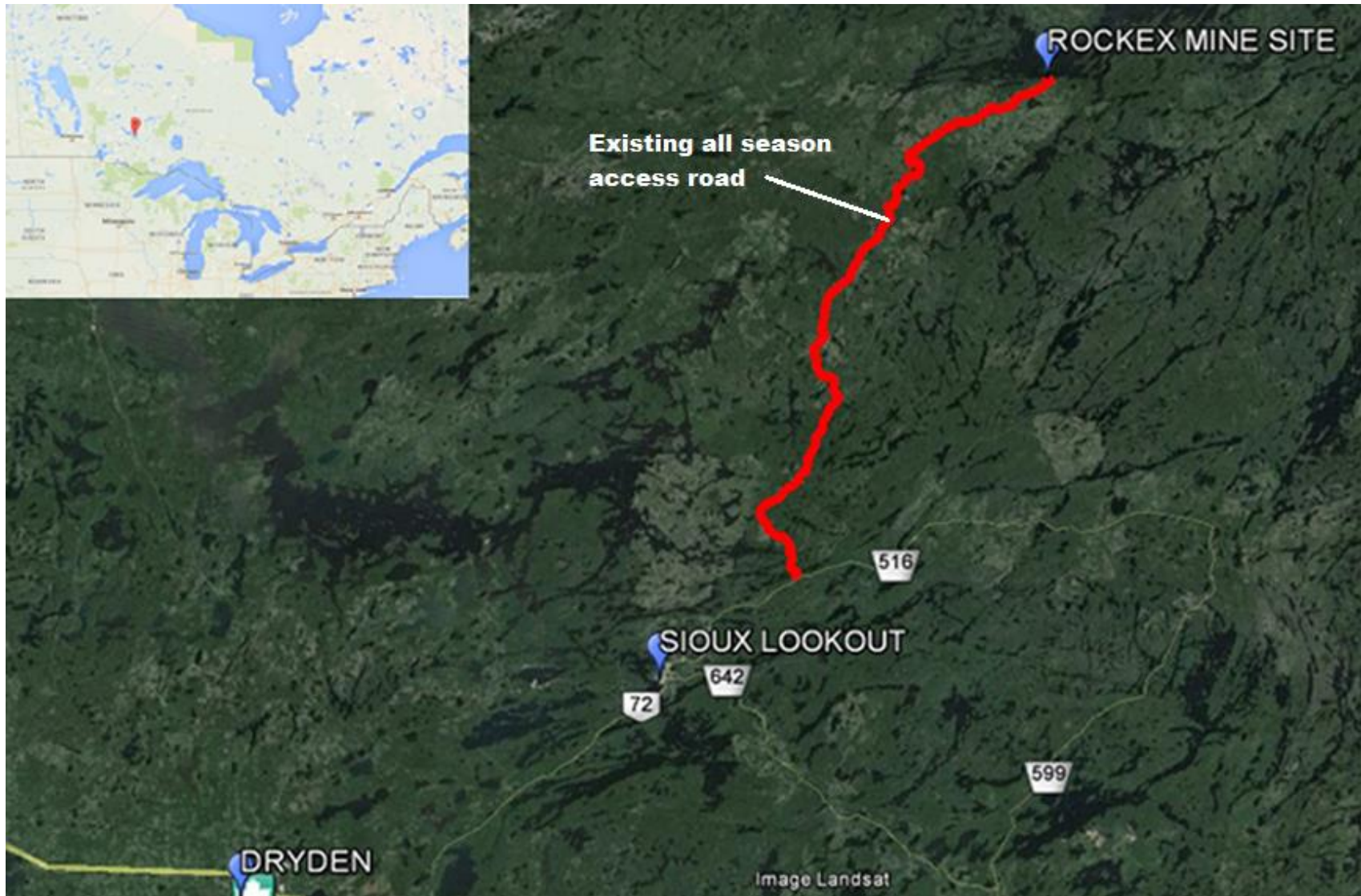
18 Project Infrastructure

18.1 General Arrangement

The Lake St. Joseph property is located approximately 100km northeast of Sioux Lookout, and 80km southwest of Pickle Lake. The open pit is located on Eagle Island in the southwest part of the lake. The waste and overburden dumps, the crushing plant, the concentrator and tailings pond are all situated on the south shore of Lake St. Joseph. A causeway of approximately 1.3 km will link the island to the south shore. Drainage ditches will be constructed around the open pit and dumps to direct water runoff to settling ponds to avoid contamination. The mineralized material will be hauled by the mine haul trucks to a gyratory crusher located in proximity to the concentrator. A haulage road will be constructed between the mine and the crushers. All crushed material will be sent via a conveyor to be stockpiled, and, subsequently reclaimed and transported to the concentrator via a short conveying system. The annually produced 6 Mt of iron concentrate will be pumped to Sioux Lookout for further processing.

The facilities in Sioux Lookout will be located in proximity to an existing railway line. The pumped slurry will be collected into storage tanks. First, the concentrate slurry will be dewatered to become pellet feed. Afterwards, in the pelletizing plant it will be processed into iron pellets. Finally, the pellets will be transformed to Hot Briquetted Iron (HBI) in the direct reduction plants. The final annual production will be 4.3 Mt of HBI. The HBI will be conveyed to a stockpile. It will be reclaimed and then it will be loaded on trains to be shipped to customers. Figure 18-1 shows the general location map with the planned project development.

Figure 18-1 – General Location Map



CIMA+ M03802A

18.2 Lake St.-Joseph Area

18.2.1 Site Access and Roads

The mine site can be accessed through a series of paved roads and unpaved forestry roads for an approximate total of 140 km of road. Approximately 40 km of road close to the mine site will need be upgraded or relocated.

At the site, access and haulage roads will be built to provide access to the following areas:

- Mine pit;
- Mine dumps;
- Crusher;
- Concentrator;
- Tailings pond;
- Explosives storage;
- Maintenance garage;
- Fresh water source;
- Fuel farm;
- Telecommunication tower;
- Helicopter pad.

All roads are designed to minimize the required cut and fill. Site roads will be 10 m wide and the maximum grade of these roads is 7%. Haulage roads will be 30 m wide and the maximum grade of these roads is 10%. The earth excavation will be used to backfill the lower points on the road alignment. The rock excavation will be used without any further crushing for the sub-base for a thickness of 1,000 mm. The final base of the road will have a thickness of 400 mm and will be made of crushed stone (MG-20).

18.2.2 Security Gate House

A security gate house is not required at the mine site.

18.2.3 Fuel Storage and Filling Station

The fuel storage facility will contain diesel fuel for the mine equipment and gasoline for small vehicles. There will be two mine truck diesel fueling pumps and one gasoline pump.

18.2.4 Explosives Preparation and Storage

The explosives preparation and storage facilities will be constructed in a remote. It will be designed to the specifications and requirements of an explosives supplier. A dedicated access road serves the explosives storage area.

18.2.5 Accommodation Camp

The accommodation camp will need to include housing to accommodate 220 workers, a cafeteria large enough to accommodate all shift workers and supervisors, a meal preparation section, including all required cooking appliances and utilities, including refrigerators for food preparation. It will also include an entertainment/recreation room, and a medical clinic facility for first aid and minor interventions to serve the camp.

A rented construction camp will be erected at the beginning of the construction period, to accommodate the construction labor.

18.2.6 Administration Building

Part of the accommodation camp will house the administration offices and some conference rooms. It will include the offices for the supervisory personnel as well as safety and first aid personnel. The main offices will be at Sioux Lookout.

18.2.7 Site Drainage and Settling Ponds

A storm drainage system will be excavated that will exploit the natural drainage around roads, infrastructures and pads with a network of open ditches and culverts that will connect with one or more settling ponds.

Ditches and culverts will be designed for a 1 in 100 year recurrence event and will be checked for peak intensity flows. Sedimentation ponds will also be designed for a 1 in 100 year recurrence event.

18.2.8 Helicopter Pad

For emergency transport, a helicopter pad with a hangar will be built.

18.2.9 Services

Electrical power will be supplied to the site by tapping onto an existing nearby high voltage overhead line. A substation will be built near the plant and supply power to all the facilities at the site, such as the mine site, accommodation camp, the concentrator and other facilities.

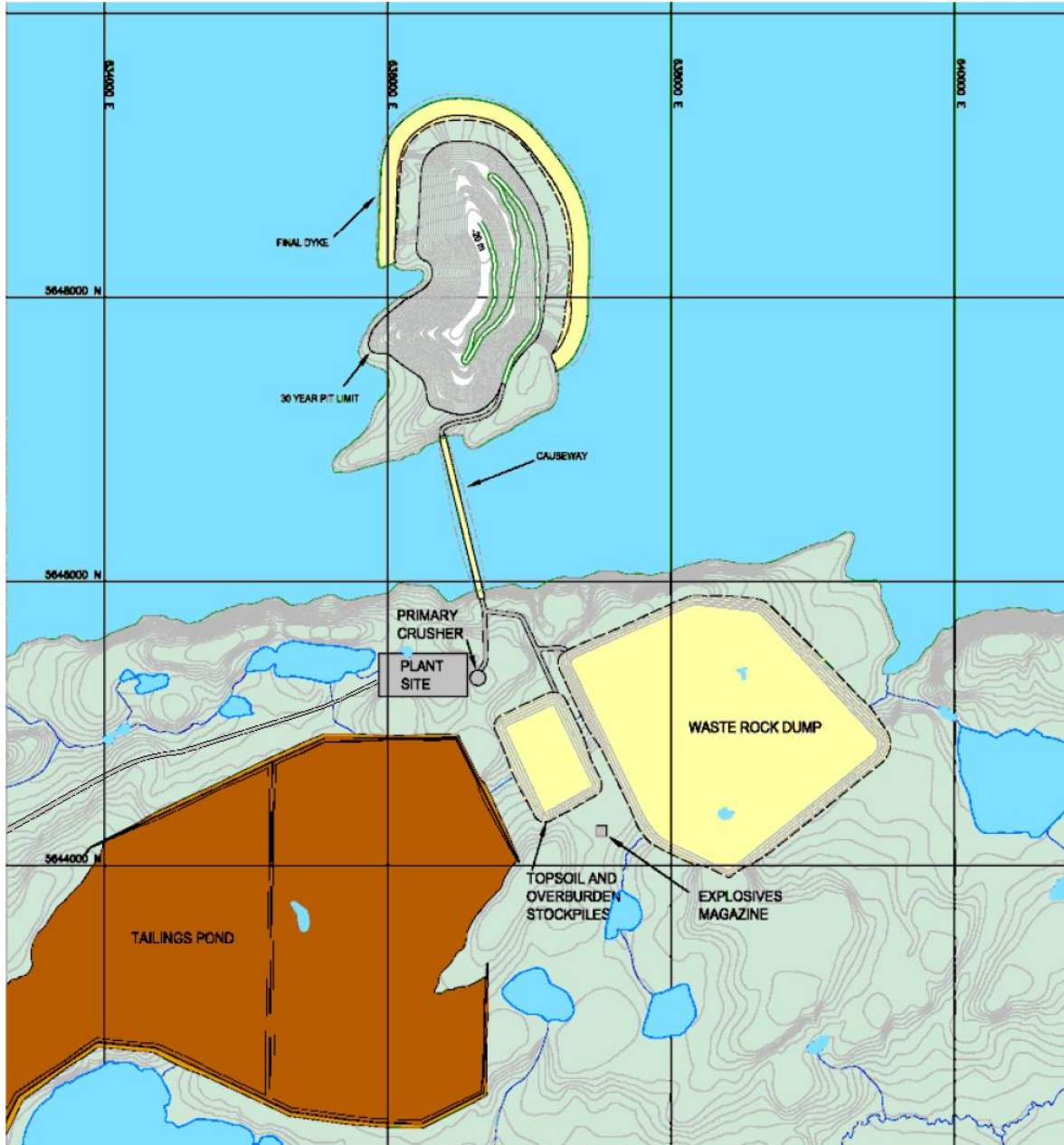
A pump house will be constructed on the shore of Lake St-Joseph near the concentrator plant site. Water will be pumped to a water treatment facility located inside the concentrator.

Central organic waste collection and on site composting equipment will be provided and inorganic waste will be disposed into an incinerator.

18.2.10 Communications

Telecommunications and radio systems will be provided to enable communication between individuals working in the different areas, as well as provide computer and internet services in all offices, control rooms etc. Figure 18-2 shows the general arrangement of the mine site.

Figure 18-2 – General Arrangement of the Mine Site



CIMA+ M03802A



18.3 Concentrate Pipeline

A pipeline will be used to transport the iron ore concentrate from the mine site to the Sioux Lookout site. It will be approximately 135 km long buried pipeline. The pipeline will be approximately 400 mm in diameter transport the 6 Mtpy concentrate. The routing and exact diameter of the pipeline will be determined at the next level of study.

18.4 Sioux Lookout Area

18.4.1 Security Gate House

A security gate house will be installed on the main access road. The guard will authorize the entree of visitors to the site.

18.4.2 Accommodation Camp

No accommodation camp is necessary since the majority of the workforce will come from the town of Sioux Lookout. There will be a kitchen and lunchroom at the site.

18.4.3 Administration Building

The administrative building will be constructed beside the pellet plant. The administration building will house the offices for the project managers and other supervisory personnel as well as the plant supervisors, secretary, accounting, human resources, safety and first aid personnel.

18.4.4 Site Drainage and Settling Ponds

A storm drainage system will be excavated that will exploit the natural drainage around roads, infrastructures and pads with a network of open ditches and culverts that will connect with one or more settling ponds.

Ditches and culverts will be designed for a 1 in 100 year recurrence event and will be checked for peak intensity flows. Sedimentation ponds will also be designed for a 1 in 100 year recurrence event.

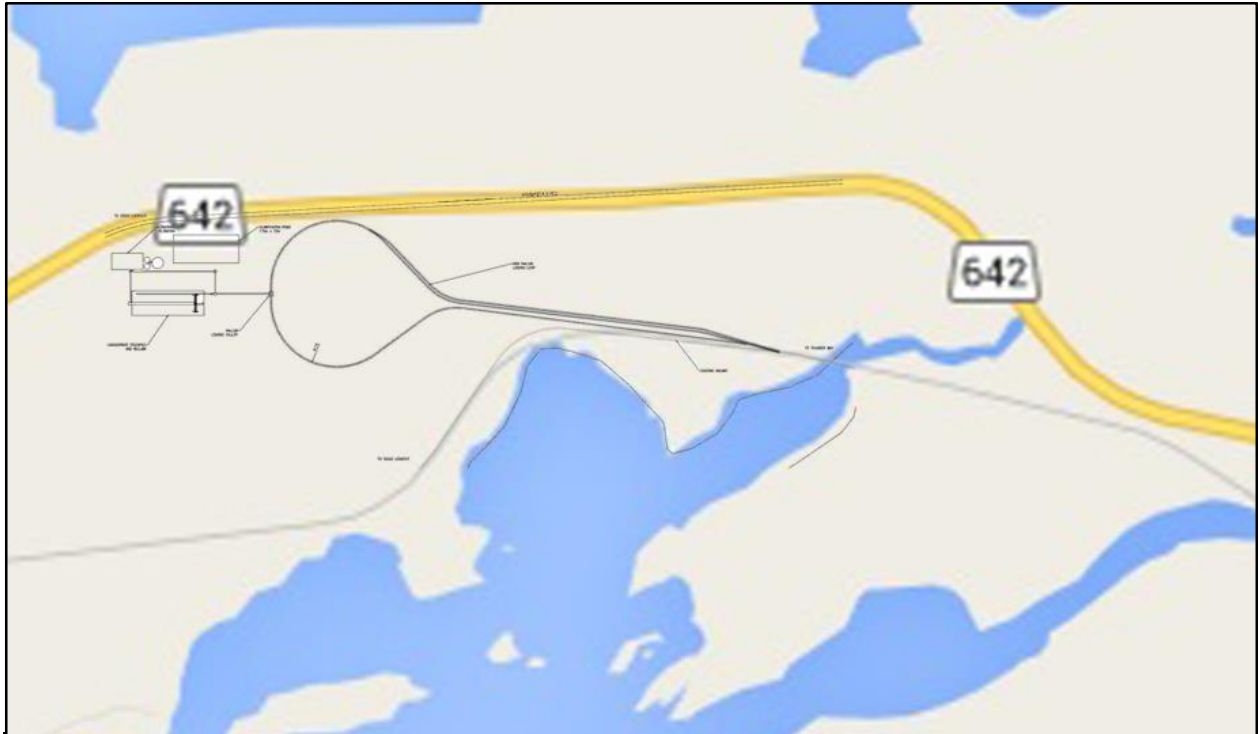
18.4.5 Services

Electrical power will be supplied to the site by tapping onto an existing nearby high voltage overhead line. A substation will be built near the plant and supply power to all the facilities at the site, such as the dewatering plant, the pellet plant, the direct reduction plant and other facilities.

18.4.6 Communications

Telecommunications and radio systems will be provided to enable communication between individuals working in the different areas, as well as provide computer and internet services in all offices, control rooms etc. Figure 18-3 shows the general arrangement of the Sioux Lookout site.

Figure 18-3 – General Arrangement of the Sioux Lookout Site



CIMA+ M03802A



19 Market Studies and Contracts

19.1 Market Overview

The Rockex project is located just north of the Great Lakes, which will allow a strategic position to supply the steel producers of North America and especially those around the Great Lakes. The product of 4.3 Mtpy will have a point of sale from Sioux Lookout.

All steel producers require steel scrap to produce steel, whether they run electric arc furnaces (EAF), blast furnaces (BF) or basic oxygen furnaces (BOF).

In a World Steel Dynamics (WSD) report, they forecast that between 2011 and 2020, the requirements for scrap metal for steelmaking may grow faster than the scrap that is available. This imbalance may lead to a variety of consequences for the price of scrap, including: more frequent 'price spikes'; increased demand for scrap substitutes such as HBI; higher on average prices for steel scrap.

According to an International Iron Metallics Association (IIMA) report, there are already 26 countries with some restriction on steel scrap exports. Restrictions range from increased taxation on scrap exports to complete bans.

HBI is complementary and an excellent metallic alternative to scrap steel. HBI is a premium quality, high density steel industry raw material containing 90-94% total iron (Fe) in a nearly pure form, which is used in EAF and BOF steelmaking, BF ironmaking, and foundry applications.

Hot Briquetted Iron (HBI) Advantages:

- High bulk density of 5000 kg/m³ (312 lbs/ft³).
- Known, consistent chemistry certified by the producer.
- Minimal amounts of undesirable chemical elements (Cu, Ni, Cr, Mo, Sn, Pb, and V).
- High thermal and electrical conductivity
- Low reactivity with fresh and saltwater (reoxidation).

Table 19-1 shows the current and forecasted production of DRI/HBI.

Table 19-1 – DRI/HBI Production by Country/Region (Mtpy)

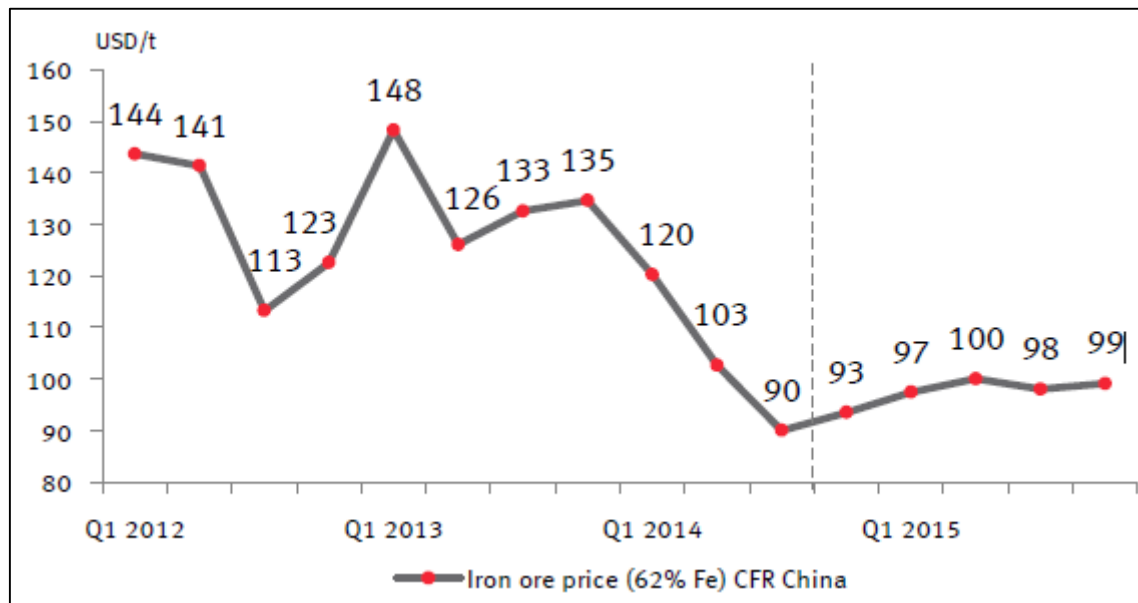
Country	2008	2009	2010	2011	2012	2013	2014	2015	2020	2025
USA and Canada	1.0	0.3	0.6	0.7	0.6	0.6	2.7	3.2	5.9	8.5
United States	0.3	0.0	0.0	0.0	0.0	0.0	2.0	2.5	5.0	7.5
Canada	0.7	0.3	0.6	0.7	0.6	0.6	0.7	0.7	0.9	1.0
Latin America Region	17.9	12.7	14.3	15.1	15.8	16.3	17.2	18.0	22.2	27.3
Europe and Russia	5.1	5.1	5.2	5.6	5.7	5.8	5.9	7.7	9.2	10.3
MENA Region	18.3	19.4	22.3	28.5	26.8	26.8	27.2	27.7	33.1	38.7
Africa, Asia ex China	25.6	27.0	28.3	26.9	28.7	30.5	32.9	35.2	47.5	61.4
China	0.2	0.0	0.7	0.0	0.5	0.6	2.0	3.5	15.1	20.1
India	21.2	22.0	23.4	22.0	24.2	26.0	28.1	30.1	41.1	53.4
World Total	68.0	64.4	71.3	76.7	78.2	80.5	87.9	95.2	132.9	166.3

Source: World Steel Dynamics

19.2 Iron Ore Pricing for Project Financial Evaluation

In November 2014, a world leading producer of HBI (Metalloinvest) made a presentation at “BofAML Russia & CIS 1-1 Conference”. In this presentation, they were demonstrating the high stability of the HBI, comparing to the iron ore and pellet premium. The Figure 19-1 show the historic price of iron ore, the Figure 19-2 illustrates the historic price of pellet premium and the Figure 19-3 show the historic HBI price.

Figure 19-1 - Iron ore price banks' average forecast



CIMA+ M03802A



Figure 19-2 - Pellet premium

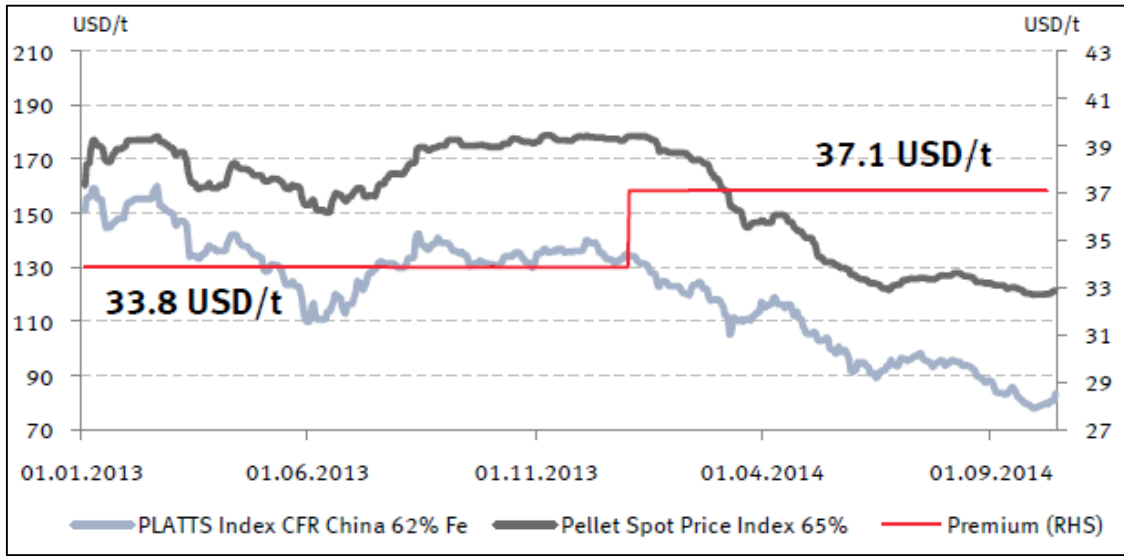
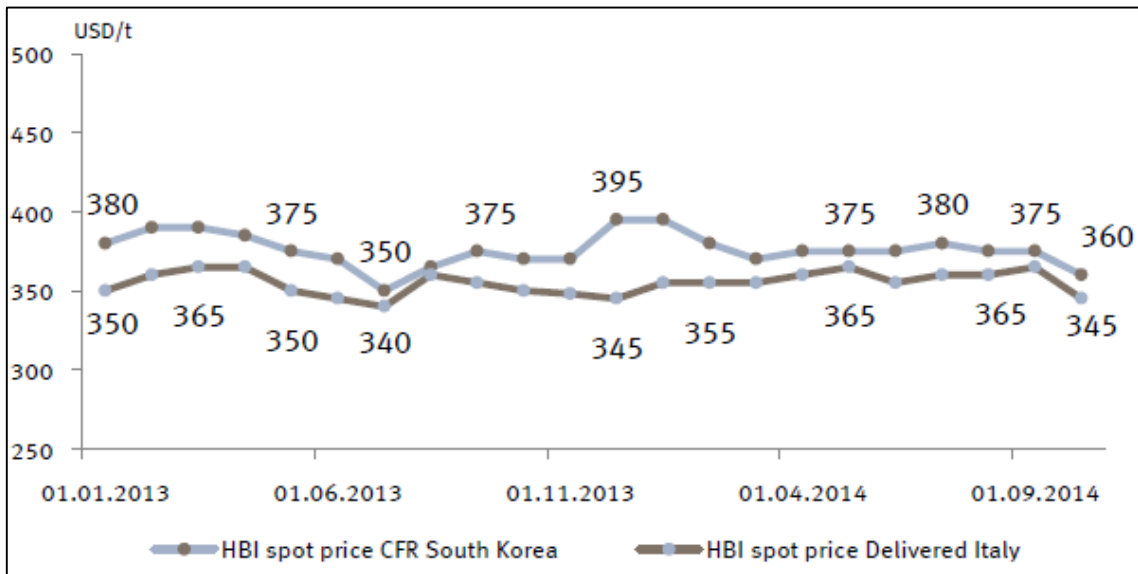


Figure 19-3 - HBI price dynamics



For the PEA Study, the long term price of HBI is forecasted at US\$350/t FOB Sioux Lookout, rail loading yard.

20 Environmental Studies, Permitting and Social Community Impact

20.1 Environmental Studies

No recent environmental baseline studies have been conducted on the Project. WGM reported, in their 2011 Technical Report on the Property, that a comprehensive Environmental Impact Assessment was prepared in the early 1970s. A draft report titled: *“Environmental Assessment of the Lake St. Joseph Project, Steep Rock Iron Mines Limited, Atikokan, Ontario”* was published by Bechtel in 1975. According to WGM’s Technical Report, this report, AMICUS No. 158005955, is in the library collections of the University of Waterloo and at Lakehead University.

The scope of baseline information to produce environmental assessments for regulators will need to include physical, biological and social aspects of the environment for the three (3) main components of the Project (the Eagle Island mining complex, the concentrate pipeline and the Sioux Lookout pellet feed filtering and shipping facility):

- Geomorphology and detailed map of topographical features (lake, streams, wetland, etc.);
- Local meteorological information (temperature, precipitation and wind);
- Ambient air quality;
- Soils characteristics and historical land use;
- Surface water and groundwater existing quality;
- Assessment of flora, fauna as well as avifauna;
- Archeological potential;
- Local social and demographical information;
- Stakeholders.

Preliminary indications show that mineralization or waste rock should not be acid generating: most of the core samples have been tested with a %S less than 0.3%. Consequently, design at the PEA level has considered that mineralization, tailings and waste rock are not acid generating.

Nonetheless, in order to rule out problematic acid rock drainage or metal leaching, geochemical testing will need to be conducted in the subsequent phases of the Project, on mine rock and tailings samples, for an assessment of the metal leaching and acid rock drainage potential of mine wastes generated by the Project.

20.2 Permitting

The Ministry of Northern Development and Mines (“MNDM”) is responsible for coordinating and overseeing the permitting process of mining projects in the province of Ontario.

Federal laws and regulations that could have significant direct impact on the proposed Project include the Canadian Environmental Protection Act (“CEPA”), the Canadian Environmental Assessment Act (“CEAA”) and the Fisheries Act.

The Fisheries Act applies to any body of water that may contain fish. As a result, the Department of Fisheries and Oceans applies the “no net loss” guiding principle, so that unavoidable fish habitat losses as a result of development Projects are balanced by newly created and/or restored fish habitat. Emphasis should be made in developing a construction procedure for the causeway and dams that will include work plans to limit fish mortality. Table 20-1 identifies the main permits and authorizations falling within both provincial and federal jurisdiction that will be required for the construction and operation of the Project.

Table 20-1– Preliminary List of Provincial and Federal of Required Permits and Approvals

Project Component	Ministry and Applicable Law/Rule/Guideline	Documentation Required
Bulk Sample Collection for Test Work	Ministry of Northern Development and Mines Mining Act (Ontario Regulation 240/00) Public Lands Act (Ontario Regulation 349/98)	Closure plan and work permit
Construction of Dams	Ministry of Natural Resources (“MNR”) Public Lands Act (Ontario Regulations 975/90 and 453/96)	Permit request
	Ministry of Natural Resources (MNR) Lakes and Rivers Improvement Act (Ontario Regulation 454/96)	Permit request
	Department of Fisheries and Oceans (“DFO”) Fisheries Act (Regulation SOR/93-53)	Fish habitat authorisation and compensation plan.
Construction of Electrical transmission Line	Ministry of Environment Environmental Assessment Act	Class Environmental Assessment
Settling Ponds and Tailings Dams	Ministry of Environment Environmental Protection Act (Regulation 560/94) Water Resources Act (Regulation 561/94)	Environmental Compliance Approval (ECA)
Air & Noise Emission	Ministry of Environment Environmental Protection Act (Regulation 419/05)	Environmental Compliance Approval (ECA)
Waste Generation	Ministry of Environment Environmental Protection Act (Regulation 347/90)	Permit
Water Abstraction	Ministry of Environment Environmental Protection Act (Regulation 87/04)	Permit
Building Construction Permit	Municipality (Building Code)	Permit
Building Construction on Crown Land	Ministry of Natural Resources (MNR) Environmental Assessment act	LOO, Lease, Easement or Freehold Patent

CIMA+ M03802A



Project Component	Ministry and Applicable Law/Rule/Guideline	Documentation Required
Designated Project : Mine Site Development (Mine, Concentrator, Pipeline and Filtration Plant), with Federal Interest	Canadian Environmental Assessment Agency (triggered by Regulations Designating Physical Activities (SOR/2012-147))	Environment Assessment Approval
Mine Site Development (Mine, Concentrator, Pipeline and Filtration Plant), with Provincial Interest	Ministry of Natural resources (MNR) Public Lands Act (Regulation 975/90 and Regulation 453/96)	Work permit
Mine Site Development	Occupational Health and Safety Act (Regulation 854/90-mines and mining plants)	Pre-development review process
Aggregate Extraction	Aggregate Resources Act (Regulation 244/97)	Aggregate permit
Development of Mining Process Facilities with Emissions to Water	Environmental Protection Act (discharge of industrial wastewater to surface water)	Environmental Compliance Approval (ECA)
Waste Management – (if a Waste Disposal Site Construction and Operation will be Required for Project)	Environment Protection Act	Environmental Compliance Approval (ECA)
Sewage Treatment Facility – Construction and Operation	Environment Protection Act	Environmental Compliance Approval (ECA)
Explosive Magazines	Explosives Act (Section7)	Permit
Mine Closure Plan	Mining Act (Regulation 240/00)	Verification of closure plan completion

20.3 Project Stakeholders

The Project Stakeholders should be identified early in the Project and their issues/potential impacts/concerns should be monitored closely. WGM 2011 Technical Report has identified sets of logging roads permitted to Mackenzie (“Buchanan”) Forest Products Inc. and the use of a concession for exploration camp granted to Bowater Canadian Forest Products Inc. In addition, it is expected that Lake St. Joseph tourist operators,

CIMA+ M03802A



Various Crown Ministries, the Municipality of Sioux Lookout and Aboriginal communities will need to be consulted.

20.3.1 Aboriginal

In its 2011 Technical Report, WGM had identified the local communities in the Lake St. Joseph area. There are two (2) principle Ojibway Aboriginal communities in the immediate area of the Property, namely the Mishkeegogmang First Nation and the Slate Falls First Nation. The Mishkeegogmang First Nation communities are located along Highway 599 at the east end of Lake St. Joseph and include at least 10 settlements with a total population of 1,774, including two (2) reserves. The Osnaburgh 63A Reserve, which includes the village of Mishkeegogamang, is located at the northeast end of the Lake. The Osnaburgh 63B Reserve is located south of the Lake. Connie Gray-McKay is the Chief of Mishkeegogmang.

The Aboriginal community of Slate Falls is located approximately 40 km northwest of the Property. Slate Falls has a population of about 260 and is a member of the Windigo Aboriginal Council and its Chief is Lorraine Crane.

Both the Mishkeegogamang Aboriginal/Communities, and the Slate Falls Nation/Community are members of the Nishnawbe-Aski Nation (“NAN”) political organization of northwestern Ontario.

The Ontario government strongly recommends that mining companies maintain dialog with local Aboriginal communities so activities can be coordinated to avoid any conflict between exploration and traditional activities.

The Mining Act was recently amended (April 2013) and clarified the requirements for Aboriginal consultation.

Rockex has initiated preliminary engagement activities with the two (2) main Aboriginal communities identified by the Ontario Crown and has notified them of its exploration activities. Met-Chem agrees with WGM recommendations that these notifications continue and that regular meetings are held to foster a good relationship.

Met-Chem understands that management of Rockex have met with representatives of the Mishkeegogamang and Slate Falls communities. Apparently most of the discussions centered around the

conduct of exploration activities on its claims and employment opportunities among members of those communities that a mining operation may generate of the Property.

20.4 Mine Closure and Rehabilitation

20.4.1 Introduction

The requirements for closure plan are identified under the Ontario Mining Act in Schedule 1 and 2.

The objective of the regulation is to constitute full, true and plain disclosure of the rehabilitation work currently required to restore the site to its former use or condition or to make the site suitable for a use the Director sees fit in accordance with the Mining Act and Regulation. Monitoring programs of approved closure plans will be tailored for the specific site. A Mine Closure Plan must be approved prior to commencing mine development. The Closure Plan must detail the following information:

- Project Information;
- Current Project Site Conditions;
- Project Description;
- Progressive Rehabilitation;
- Rehabilitation Measures-Temporary Suspension;
- Rehabilitation Measures-State of Inactivity;
- Rehabilitation Measures-Closed Out;
- Monitoring;
- Expected site Conditions;
- Costs;
- Financial Assurance.

The security payment of the costs of rehabilitating the accumulation areas is to be posted starting year 1. Provision have been made in the economic analysis for the disbursement of 100% of the estimated cost of rehabilitation in the first year of the Project.

In the closure plan, all the related infrastructures of the project will be demolished at the end of the project, however, this infrastructure was not taking into account for in the estimates of closure cost. Generally the resale of equipment and steel equate to the cost of demolition.

20.4.2 Closure Cost

The preliminary cost estimate of the rehabilitation and closure plan is based on the re-sloping and revegetation of the tailings storage facility and the re-vegetation of the top and berms of the waste rock dumps, which usually represents the largest proportion of rehabilitation costs.

Since most of the core samples have been tested with a % S less than 0.3%, it was assumed that neither the tailings nor waste rock should be acid generating.

Preliminary rehabilitation design of tailings pond and waste rock stockpile is based on a layer of overburden and re-vegetation.

Based on the accumulation areas identified in Table 20-2 the total cost for the rehabilitation of the tailings storage facility and waste rock dumps has been estimated at \$65.7 M. It is assumed that any topsoil or overburden made available through mining will be reused in the rehabilitation.

Table 20-2 – Accumulation Areas for Waste Rock Dump and Tailings Storage Facility

Accumulation Areas	Unit	Area
Tailings Pond (years 1 to 30)	m ²	17,583,000
Waste Rock Dump Area	m ²	2,951,000

The site rehabilitation and closure plan will be reviewed as the Project advances through pre-feasibility study and construction stage to include baseline studies results as well as revegetation site parcel studies to assess plant growth potential.

20.5 Recommendations

Meetings and consultation with Stakeholders should continue as the Project progresses to pre-feasibility study.

A summary table of issues/potential impacts identified by stakeholders should be maintained closely.

CIMA+ M03802A



A detailed schedule of environmental permitting requirements will need to be prepared. This schedule should be integrated in the master schedule of the Project.

It is recommended to conduct acid rock drainage and metal leaching testing on mine rock and tailings samples.

21 Capital and Operating Costs

21.1 Capital Cost Estimate

This section covers the capital cost estimate for implementation of the mining, concentrating, handling, pelletizing and briquetting as well as related infrastructures required for the development of the Lakes St. Joseph Project. The following paragraphs outline the methodology used by CIMA+ personnel for the estimation of the capital cost of the project. The resulting estimate is based on the application of standard methods required to achieve an estimate with an accuracy range of +/- 35%.

21.1.1 Scope of Estimate

The capital cost estimate covers all or some of the following areas depending on the option:

- Mining: initial cost for rolling stock, causeway, field services, site infrastructures as well as electrical distribution;
- Crushing and stockpiling: gyratory crushers, access ramp, stockpile feed conveyors, stockpile reclaim conveyors and transport conveyors;
- Concentrator plant: feed conveying from crushed ore stockpiles, grinding, gravity separation, magnetic separation and desliming;
- Tailings: tailings thickeners, pumps and pipelines;
- Concentrate slurry pipeline to Sioux Lookout;
- Concentrate thickening and pelletizing facilities;
- Briquetting facilities;
- Load out facilities, Final product storage and rail car loading facilities;
- Infrastructures and services: access & plant roads, electrical substation and distribution, process & gland seal water, reclaim water, potable water, domestic waste water treatment plant, fire water distribution, HVAC, compressed air, administration building, workshop, warehouse, accommodation camp, security gate;

21.2 Summary of the Capital Cost Estimate

The capital cost of the project is the cost for the initial development of the project. When additional capital expenditures are planned for future capital equipment additions and replacements they will be charged as sustaining capital expenditures. Table 21-1 shows the summary of the capital cost estimate.

Table 21-1 – Summary of Capital Cost Estimate

Description	Cost (\$'000)
Direct Cost	
Causeway	12,144
Mine	137,246
Concentrator & Tailings	501,838
Mine Infrastructures	78,843
Concentrate Pipeline	218,173
Pellet Plant	832,481
Hot Briquetted Iron Plant	1,550,000
Rail and load-out	4,260
Sioux Lookout Infrastructures	76,756
Total Direct Cost	3,411,741
Indirect Costs	
Project Indirect	154,389
Contingency	205,852
Total Indirect Cost	360,241
Total Project Cost	3,771,982

21.2.1 Mine Capital Cost

The capital cost for the Mining area includes the initial development of the open pit mine, including the haul roads from the gyratory crushers to the mine workshop. It includes the planned pre-stripping and development of the areas for the overburden stockpile and the waste dump. It includes the purchase of all initially purchased mining equipment required for the first two (2) years of operations (year of pre-production and the first year of production). The summary of the capital cost for the mine is shown in Table 21-2.

Table 21-2 – Summary of Mine Capital Cost Estimate

Description	Cost (\$'000)
Major Equipment	73,711
Support Equipment	22,845
Service Equipment	5,734
Mine Development	33,456
Haulage Road	300
Mine Dispatch and Software	1,000
Explosive Facilities	200
Total	137,246

21.2.2 Concentrator & Tailings

The capital cost for the concentrator includes the costs for the buildings and foundations as well as the costs of all mechanical equipment for the crushers, the conveyors, concentrator and the tailings management facilities. It also includes the costs for services, power and its distribution as well as that for communications. Table 21-3 shows the summary of the total estimated costs for the concentrator and tailings.

Table 21-3 – Summary of Concentrator and Tailings Capital Cost Estimate

Description	Cost (\$'000)
Civil & Building Works	174,889
Instrumentation & Automation, Communication	16,112
Mechanical Equipment	190,010
Piping & Pipelines	32,755
Services And Supplies	12,882
Electrical	38,664
Tailings Pipelines And Spigot	1,326
Tailings Storage Facilities (5 Years Capacity)	35,200
Total	501,838

21.2.3 Mine Infrastructures

The cost of the infrastructures includes the costs for the various site roads as well as the cost of the buildings. The main roads are the access road to the mine site, the roads between the accommodations. The accommodation camp and related facilities are included in this area, as well as the laboratory building,



warehouse complex and helicopter pads. Table 21-4 shows the summary of the capital cost of the mine infrastructures.

Table 21-4 – Summary of Mine Infrastructures Capital Cost Estimate

Description	Cost (\$'000)
Fuel Storage And Distribution at Plant	3,230
Mobile Equipment	13,135
Buildings (Accommodation, Warehouse, Laboratory, etc.)	19,398
Electric Power and Communication	15,524
Site Preparation and Roads	21,606
Fire Protection	3,825
Potable Water and Waste Water	2,125
Total	78,843

21.2.4 Concentrate Pipeline

The capital cost for the concentrate pipeline is estimated at \$218,173,000.

21.2.5 Pellet Plant

The capital cost for the pellet plant is estimate as a technology supplier design and supply the process and where the construction packages are provide by various contractors. The pellet plant included the concentrate drying, additives receiving and handling, balling and induration and all the services required. Table 21-4 shows the summary of the capital cost of the pellet plant.

Table 21-5 – Summary of Mine Infrastructures Capital Cost Estimate

Description	Cost (\$'000)
Technology Supplier Package	
Engineering and Project Management	20,276
Equipment Supply	274,901
Supply of Electrical And Automation Equipment	82,799
Advisory Services and Training Services	23,421
Spare Parts for Commissioning	2,750
Construction Package	
Auxiliary Facilities	6,338
Civil Work	157,022
Mechanical Equipment Installation	189,267
Steel Structural Building Supply and Installed	75,707
Total	832,481

CIMA+ M03802A



21.2.6 Hot Briquetted Iron Plant

The capital cost for the hot briquetted iron plant is estimate as a technology supplier design and supply the process and where the construction packages are provide by various contractors. Table 21-6 shows the summary of the capital cost of the hot briquetted iron plant.

Table 21-6 – Summary of Hot Briquetted Iron Plant Capital Cost Estimate

Description	Cost (\$'000)
Technology Supplier Package	940,000
Construction Package	610,000
Total	1,550,000

21.2.7 Railroad and Rail Yard

The capital cost for the rail is estimated at \$4,260,000.

21.2.8 Sioux Lookout Infrastructures

The cost of the infrastructures includes the costs for the natural gas pipeline, offices and gatehouse. A summary of the costs is shown in Table 21-7.

Table 21-7 – Summary of Sioux Lookout Infrastructures Capital Cost Estimate

Description	Cost (\$'000)
Natural Gas Pipeline	66,950
Mobile Equipment	1,700
Buildings (Office & Gatehouse)	1,573
Site Preparation	6,120
Potable Water and Waste Water	413
Total	76,756

CIMA+ M03802A



21.2.9 Project Indirect Costs

The indirect costs for the projects consist of EPCM management, external engineering consultants, procurement, construction services, construction indirect costs and contingencies. A summary of the project indirect costs is shown in Table 21-8.

Table 21-8 – Summary of Capital Cost Estimate of the Indirect Costs

Description	Cost (\$'000)
Project Indirect (15% of direct cost)	154,389
Contingency (20 % of direct cost)	205,852
Total	360,241

21.3 Capital Cost Basis of Estimate

21.3.1 Currency Base Date and Exchange Rate

The capital cost estimate is expressed in 2nd quarter 2015 Canadian dollars. Prices obtained in other currencies were converted using currency exchange rates.

21.3.2 Items from the 2013 PEA

The estimate of items developed in the 2013 PEA by Met-Chem was reviewed and compared with CIMA+ internal database. CIMA+ also adapted the scenario at Sioux Lookout to reflect the modifications proposed.

21.3.3 Additional item added to the project from original PEA

The pellet plant was estimated with a recent quotation from a similar project. CIMA+ adjusted the quotation to reflect the capacity and the regional conditions.

A technology supplier at a conceptual level developed the hot briquetted iron plant and a budgetary cost at +/- 35%.

21.4 Mine Closure and Remediation Cost Estimate

Provisions are made for closure and rehabilitation costs in the sustaining capital, based on details given in Section 20.0. It is assumed that the salvage value of the equipment will cover the closure cost of the industrial sites.



21.5 Sustaining Capital Cost Estimate

The Sustaining Capital costs are the capital expenditures during the life of the mine that are required to maintain or upgrade the existing asset and to continue the operation at the same level of production.

The sustaining capital cost estimates for the life of mine are summarized in the Table 21-9 to

Table 21-13.

Table 21-9 – Summary of Sustaining Capital Cost Estimate (Year 1 to 6)

Area	Year 1 (\$'000)	Year 2 (\$'000)	Year 3 (\$'000)	Year 4 (\$'000)	Year 5 (\$'000)	Year 6 (\$'000)
Open Pit Mine	0	16,686	0	0	22,498	2,470
Process Mine Site	0	517	517	517	517	517
Tailings and Water Management	0	0	17,667	17,667	0	0
Infrastructure Mine Site	0	1,333	1,333	1,333	1,333	1,333
Causeway and Dykes	8 316	24 411	18 554	5 074	5 074	5 074
Process Area Sioux-Lookout Site	0	172	173	173	172	172
Infrastructures Sioux-Lookout Site	0	445	445	445	445	445
TOTAL	8,316	43,564	38,689	25,209	30,039	10,011

Table 21-10 – Summary of Sustaining Capital Cost Estimate (Year 7 to 12)

Area	Year 7 (\$'000)	Year 8 (\$'000)	Year 9 (\$'000)	Year 10 (\$'000)	Year 11 (\$'000)	Year 12 (\$'000)
Open Pit Mine	2,470	2,470	2,470	2,470	20,490	20,490
Process Mine Site	517	517	517	517	517	517
Tailings and Water Management	0	0	0	0	0	0
Infrastructure Mine Site	1,333	1,333	1,333	1,333	0	0
Causeway and Dykes	51,752	51,752	0	0	0	0
Process Area Sioux-Lookout Site	172	172	172	172	172	172
Infrastructures Sioux-Lookout Site	445	445	445	445	0	0
TOTAL	56,689	56,689	4,937	4,937	21,179	21,179



Table 21-11 – Summary of Sustaining Capital Cost Estimate (Year 13 to 18)

Area	Year 13 (\$'000)	Year 14 (\$'000)	Year 15 (\$'000)	Year 16 (\$'000)	Year 17 (\$'000)	Year 18 (\$'000)
Open Pit Mine	20,490	20,490	20,490	7,128	7,128	7,128
Process Mine Site	517	517	517	517	517	517
Tailings and Water Management	0	9,918	0	0	0	0
Infrastructure Mine Site	0	0	0	0	0	0
Causeway and Dykes	0	0	0	0	0	0
Process Area Sioux-Lookout Site	172	173	172	172	172	172
Infrastructures Sioux-Lookout Site	0	0	0	0	0	0
TOTAL	21,179	31,098	21,179	7,817	7,817	7,817

Table 21-12 – Summary of Sustaining Capital Cost Estimate (Year 19 to 24)

Area	Year 19 (\$'000)	Year 20 (\$'000)	Year 21 (\$'000)	Year 22 (\$'000)	Year 23 (\$'000)	Year 24 (\$'000)
Open Pit Mine	7,128	7,128	20,490	20,490	20,490	20,490
Process Mine Site	517	517	517	517	517	517
Tailings and Water Management	0	0	0	0	0	0
Infrastructure Mine Site	0	0	0	0	0	0
Causeway and Dykes	0	0	0	0	0	0
Process Area Sioux-Lookout Site	172	172	172	172	172	172
Infrastructures Sioux-Lookout Site	0	0	0	0	0	0
TOTAL	7,817	7,817	21,179	21,179	21,179	21,179

Table 21-13 – Summary of Sustaining Capital Cost Estimate (Year 25 to 30)

Area	Year 25 (\$'000)	Year 26 (\$'000)	Year 27 (\$'000)	Year 28 (\$'000)	Year 29 (\$'000)	Year 30 (\$'000)
Open Pit Mine	20,490	0	0	0	0	0
Process Mine Site	517	517	517	517	517	517
Tailings and Water Management	0	0	0	0	0	0
Infrastructure Mine Site	0	0	0	0	0	0
Causeway and Dykes	0	0	0	0	0	0
Process Area Sioux-Lookout Site	172	173	173	173	172	172
Infrastructures Sioux-Lookout Site	0	0	0	0	0	0
TOTAL	21,179	690	690	690	689	689

CIMA+ M03802A



21.6 Operating Cost Estimate

21.6.1 Scope and Methodology

The operating costs for the project were estimated annually, based on the mine plan developed by Met-Chem. A summary of these operating costs are shown in the followings tables. The operating costs of the average life of mine of operations have been detailed for each option and are considered representative of the typical average cost for the life of the mine. The operation has been divided into six (6) areas namely:

- Mining;
- Concentrating and Tailings;
- General and Administration;
- Rail;
- Pelletizing; and
- Briquetting.

The summary of the annual operating costs and the cost per tonne of hot briquetted iron for an average year of operations (Year 5), are shown in Table 21-14.

Table 21-14 – Summary of Year 5 of Operations per Area

Area	Annual Cost (\$'000)	Unit Cost (\$/t HBI)
Mining	76,560	17.88
Concentrating & Tailings	108,285	25.29
General and Administration	27,108	6.33
Rails	1,200	0.28
Pelletizing	81,918	19.13
Briquetting	284,441	66.44
TOTAL	579,512	135.35

21.6.2 Mine Operating Costs

The mine operating cost estimate was prepared by Met-Chem. The mine operating cost was estimated annually and assuming an owner's fleet. The cost is based on operating the mining equipment, the

manpower associated with operating the equipment, the cost for explosives as well as dewatering, road maintenance and other activities. A summary of the operating cost for the mine operation for an average year of operation are shown in Table 21-15.

Table 21-15 – Summary of Year 5 of Operation for Mine Sector

Description	Annual Cost (\$'000)	Unit Cost (\$/t HBI)
Loading	5,892	1.38
Hauling	24,192	5.65
Drilling & Blasting	14,112	3.30
Support & Services	8,832	2.06
Manpower	20,400	4.76
Other	3,132	0.73
TOTAL	76,560	17.88

In order to determine the operating costs, the following assumptions were used;

- Diesel Price: \$1.00/l;
- Hourly maintenance and operating cost of equipment;
- Cost of explosives was estimated with the tonnage mined.

21.6.3 Concentrating and Tailings Operating Costs

The concentrator operating cost was estimated with the annual tonnage. The various processing steps detailed in Section 17. The summary of the operating costs for concentrating operation of an average year of operation are shown in Table 21-16.

Table 21-16 – Summary of Year 5 of Operation for Concentrating Sector

Description	Annual Cost (\$'000)	Unit Cost (\$/t HBI.)
Power	41,149	9.61
Manpower	13,161	3.07
Other	53,975	12.61
TOTAL	108,285	25.29

In order to determine the operating costs, the following assumptions were used;

- Power Cost: \$0.07/kWh;

21.6.4 General and Administration Operating Costs

The general and administration costs include the operation of all the services, manpower and infrastructures required to support the operations. The operations included are:

- Site mobile equipment;
- Accommodation camp,
- Site administration including accounting, human resources, health and safety, supply chain, site maintenance, IT and security;

Table 21-17 show the summary of the operating costs for the general and administration operation of average year of operation for the four options.

Table 21-17 – Summary of Year 5 of Operation for General and Administration Sector

Description	Annual Cost (\$'000)	Unit Cost (\$/t HBI)
Material & Services	17,300	4.04
Manpower	9,808	2.29
TOTAL	27,108	6.33

21.6.5 Rail Operating Costs

The rail operating costs include only the operation in the rail yard to load the briquette into the train. Table 21-18 show the summary of the operating cost for the four options of the rail operations for an average year of operation.

Table 21-18 – Summary of Year 5 of Operation for Rail Sector

Description	Annual Cost (\$'000)	Unit Cost (\$/t HBI)
Manpower	720	0.17
Maintenance	480	0.11
TOTAL	1,200	0.28

21.6.6 Pellet Plant Operating Costs

The pellet plant operating cost was estimated for the annual tonnage. The various processing steps detailed in Section 17, are additive handling, mixing, balling and induration. The summary of the operating costs for the pelletizing operation of year 5 of operation are shown in Table 21-19.

Table 21-19 – Summary of Year 5 of Operation for Pellet Plant Sector

Description	Annual Cost (\$'000)	Unit Cost (\$/t HBI)
Power	19,286	2.40
Natural Gas	19,243	4.49
Reagent	7,990	1.87
Consumables	20,388	4.76
Manpower	15,011	3.51
TOTAL	81,918	19.13

- Power Cost: \$0.07/kWh;
- Natural Gas unit cost: \$4.49/GJ;
- Reagent unit cost:
 - Limestone: \$1.63/t of pellet;
 - Dolomite: \$0.55/t of pellet;
 - Activator: \$0.04/t of pellets;
 - Bentonite: \$0.60/t of pellets;
- Consumables annual cost:

CIMA+ M03802A



- Filter Bags: \$0.03/t of pellets;
- Filter Sectors: \$0.01/t of pellets;
- Roller: \$0.04/t of pellets;
- Refractories: \$0.03/t of pellets;
- Spares: \$1.67/t of pellets;
- Grate Bars: \$0.01/t of pellets;
- Grinding Media: \$0.04/t of pellet;
- Other Consumables: \$1.13/t of pellets.

21.6.7 Briquetting Operating Costs

The hot briquetted iron plant operating cost was estimated for the annual tonnage. The summary of the operating costs for the briquetting operation of year 5 of operation are shown in Table 21-20.

Table 21-20 – Summary of Year 5 of Operation for Hot Briquetted Iron Plant Sector

Description	Annual Cost (\$'000)	Unit Cost (\$/t HBI)
Gas (natural, O ₂ & N ₂)	217,427	50.79
Power	34,166	7.98
Consumables	6,850	1.60
Maintenance	4,000	0.93
Manpower	21,998	5.14
TOTAL	284,441	66.44

- Power Cost: \$0.07/kWh;
- Natural Gas unit cost: \$4.49/GJ;
- Oxygen unit cost: \$0.06/Nm³;
- Nitrogen unit cost: \$0.02/Nm³;

CIMA+ M03802A



21.6.8 Manpower

The site will be operating continuously, 24 hour per day with 2 - 12 hour shifts, with a turnaround every 2 weeks. The required manpower for the typical year (Year 5) has been shown in Table 21-21

Table 21-21 – Estimated Manpower Requirements (Year 5)

Position	Year 5
Mine	180
Concentration and Tailings	114
General & Administration	89
Rail	6
Pelletizing	127
Briquetting	200
TOTAL	716

22 Economic Analysis

An economic/financial analysis has been carried out for the Lake St. Joseph Project (Eagle Island deposit) using an annual concentrate production rate of 6 Mt further processed into 4.3 Mt of hot briquetted iron (HBI). The project's life is limited to 30 years of production.

A cash flow model is constructed on an annual basis in constant money terms (second quarter 2015). No provision is made for the effects of inflation. The Project is assessed on a "100%-equity" basis (i.e. unlevered cash flows) in conjunction with a discount rate that represents the cost of equity capital.

22.1 Macro-Economic Assumptions

The main base case macro-economic assumptions used are given in Table 22-1.

A long-term FOB Sioux Lookout price of 350 USD/t of product is assumed, the location from which it is to be sold to potential customers. The sensitivity analysis examines a range of prices 30% above and below the base case price

Table 22-1 – Macro-Economic Assumptions

Description	Units	Value
HBI Price (FOB Sioux Lookout) at 94% Fe	USD/t	350
Exchange Rate	USD/CAD	0.85
Base Case Discount Rate	% per year	8.0
Discount Rate Variants	% per year	6.0 & 10.0

A long-term exchange rate of 0.85 USD/CAD is assumed over the life of the Project.

The current Canadian tax system applicable to mining income is used to assess the Project's annual tax liabilities. This consists of federal and provincial corporate taxes as well as provincial mining taxes. The revisions announced in the March 21st 2013 federal budget speech concerning the reclassification of mine development expenses from Canadian Exploration Expenses (CEE) to Canadian Development Expenses (CDE), and the elimination of the provision for accelerated depreciation for class 41A assets have been accounted for. Both changes are to be made progressively over a period of several years starting in 2015. It is assumed that Ontario will follow suit with the same changes in the provincial corporate tax rules. The federal and provincial corporate tax rates currently applicable over the Project's operating life are 15% and



10% of taxable income, respectively. Based on guidelines from the Ontario Mining Act, it is likely that if developed, this Project would be classified as a “remote mine” for the purpose of Ontario Mining Taxes (this requires ultimately a certification from the Minister of Northern Development and Mines). The rate applicable for the purpose of assessing Ontario mining taxes for remote mines is 5 % of taxable income, half the normal rate of 10 %. Furthermore, as it is planned to further transform the concentrate produced at the mine into a hot-briquetted iron product at Sioux Lookout in Northern Ontario, it is assumed that the processing allowance rate is 20 percent.

The discount rate variants used to determine the NPV are meant to represent typical costs of equity capital. Results are presented on pre-tax and post-tax bases.

22.2 Royalty and Impact and Benefit Agreements

The present financial analysis incorporates a royalty payment agreement. The claims are currently active and Rockex is the 100% recorded holder of all 13 claims. The Property is subject to an Iron Royalty Agreement providing for a 2% royalty of the gross sale proceeds from any and all minerals mined and processed for their iron content or, starting in 2012, an annual advance royalty of \$250,000 per year (increasing at a rate of 10% per year) in the event that there is no commercial production from the Property. Pursuant to a cross-credit clause, advance royalty payments payable are credited against royalties payable from commercial production. The Property is also subject to a NSR Royalty Agreement which provides for 2% net smelter returns royalty payable on any and all other minerals produced (i.e. excluding those produced for their iron content) commencing on commercial production. Royalty payments made prior to 2017 (the first pre-production year) are considered sunk for the purpose of this economic analysis. No Impact and Benefit Agreement has been negotiated at this stage of project development.

22.3 Technical Assumptions

The key technical assumptions used in the analysis are shown in Table 22-1.

Table 22-2 – Technical Assumptions

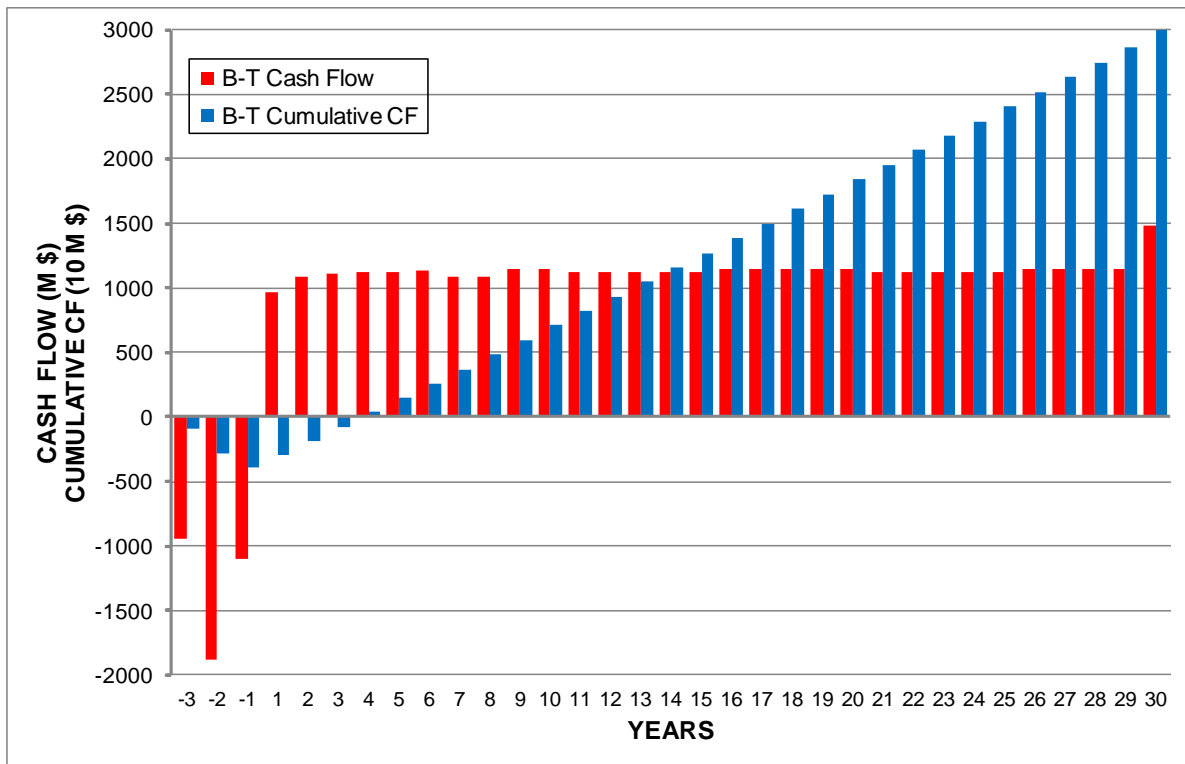
Item	Units	Value
Life of Mine Mill Feed (for financial analysis)	Mt	512.4
Average Grade	% Fe	29.0
Processing Recovery	%	80
Average Stripping Ratio	Waste / Mineralisation	0.516
Mine Life (for financial analysis)	Years	30
Annual Concentrate Production (66.3% Fe)	'000 t	6,000
Annual HBI Production (94% Fe)	'000 t	4,281
Operating Costs (excluding royalty)		
Mining	\$/t HBI	17.88
Concentrator	\$/t HBI	25.29
Pellet Plant	\$/t HBI	19.15
HBI Plant	\$/t HBI	66.46
Other		
General & Administration Costs	\$/t HBI	6.36
Rail Operation	\$/t HBI	0.28
Total	\$/t HBI	135.41
Total (based on financial analysis)	\$/t milled	33.81
Capital Costs		
Pre-production Capital Costs (excluding Working Capital)	M\$	3,772.0
Initial Working Capital	M\$	129.6
Sustaining Capital Costs	M\$	538.3
Closure Costs	M\$	65.7
Salvage Value	M\$	187.8

A reduced rate over the first six (6) months of production provides for a ramp-up to full capacity. On average, 17.1 M tonnes of run of mine material will be supplied per year to the process plant when full production is reached. The amount of concentrate produced is a function of mill feed grade, processing recovery and concentrate grade.

22.4 Financial Analysis Results

Figure 22-1 shows the pre-tax (B-T) cash flows as well as the cumulative cash flow over the project's life. The payback period corresponds to the time at which the cumulative cash flow becomes positive (between years 3 and 4 on the graph's time frame).

Figure 22-1 – Before-tax Cash Flows and Cumulative Cash Flow



The financial evaluation results based on the technical assumptions described above are summarized in Table 22-3. A cash flow statement for the base case is given in Table 22-4.

For taxation purposes, all contingencies as well as owner’s and contractor’s indirect costs were redistributed by area, as shown in the cash flow statement. Also shown is a capital cost breakdown by area and a preliminary capital spending schedule over a 3-year pre-production period.

A working capital equivalent to three (3) months of total annual operating costs is maintained throughout the production period. As operating costs vary over the mine life, additional amounts of working capital are injected or withdrawn as required. The initial working capital requirement is estimated at \$129.6 M.

Closure costs are estimated at \$65.7 M. It is assumed that financial assurance is provided in the form of rehabilitation trust fund payments at the beginning of the first three years of operation.

CIMA+ M03802A



On a pre-tax basis, the NPV is \$6,577.5 M at a discount rate of eight (8)%. The Project has an IRR of 22.5% and a payback period of 3.7 years.

On a post-tax basis, the NPV is \$4,672.6 M at a discount rate of eight (8)%. The Project has an IRR of 19.5% and a payback period of 4.1 years.

Table 22-3 – Summary of Financial Results

Description	Units	Value
Total FOB Revenue	M\$	52,682.6
Total Operating Costs (including royalty)	M\$	18,376.4
Total Pre-Production Capital Costs (excluding Working Capital)	M\$	3,772.0
Total Sustaining Capital Costs	M\$	538.3
Total Closure Costs	M\$	65.7
Salvage Value	M\$	187.8
PRE-TAX		
Total Cash Flow	M\$	30,118.0
Payback Period	Years	3.7
Net Present Value @ 8%	M\$	6,577.5
Net Present Value @ 6%	M\$	9,421.1
Net Present Value @ 10%	M\$	4,603.8
Internal Rate of Return	%	22.5
POST-TAX		
Total Cash Flow	M\$	22,624.0
Payback Period	years	4.1
Net Present Value @ 8%	M\$	4,672.6
Net Present Value @ 6%	M\$	6,850.0
Net Present Value @ 10%	M\$	3,158.2
Internal Rate of Return	%	19.5

22.5 Sensitivity Analysis

A sensitivity analysis has been carried out, with the base case described above as a starting point, to assess the impact of changes in the HBI (94% Fe) price (“PRICE”), total pre-production capital costs (“CAPEX”) and operating costs (“OPEX”) on the Project’s NPV @ 8% and IRR. Each variable is examined one-at-a-time. An interval of ± 30% with increments of 10% is used for all three (3) variables, while keeping all other parameters fixed.

Figure 22-2 and Figure 22-3 show the results of the sensitivity analysis on a pre-tax basis (B-T). These indicate that the Project's viability is not significantly vulnerable to variations in capital and operating cost estimates, taken one at-a-time. The NPV is more sensitive to variations in operating expenses, as shown by the steeper OPEX curve on the NPV diagram. However, as expected, the NPV is most sensitive to variations in price. The internal rate of return is more sensitive to variations in capital costs than operating costs, as shown by the steeper CAPEX curve. Here as well, the IRR is most sensitive to variations in price (the horizontal dashed line represents the base case discount rate of 8%).

Figure 22-4 and Figure 22-5 show the results of the sensitivity analysis on a post-tax basis (A-T). The same conclusions as those noted for the pre-tax situation can be drawn concerning the sensitivity of the post-tax financial indicators. The financial indicators of the Project remain positive at the lower limit of the price interval (this corresponds to an HBI price of USD 245/t).

Table 22-4 – Cash Flow Statement

		PEA Lake St. Joseph																												CIMA					
		ANNUAL CASH FLOWS																																	
Unit		Y-3	Y-2	Y-1	Y1	Y2	Y3	Y4	Y5	Y6	Y7	Y8	Y9	Y10	Y11	Y12	Y13	Y14	Y15	Y16	Y17	Y18	Y19	Y20	Y21	Y22	Y23	Y24	Y25	Y26	Y27	Y28	Y29	Y30	TOTAL
		2017	2018	2019	2020	2021	2022	2023	2024	2025	2026	2027	2028	2029	2030	2031	2032	2033	2034	2035	2036	2037	2038	2039	2040	2041	2042	2043	2044	2045	2046	2047	2048	2049	
All monetary values in CAD																																			
REVENUES																																			
Hot Briquetted Iron (HBI)																																			
FOB Selling Price																																			
Revenue FOB																																			
OPERATING COSTS																																			
Mine																																			
Concentrator																																			
General & Administration																																			
Rail Operation																																			
Pellet Plant Operation																																			
HBI Plant Operation																																			
Gross Sales Royalty (\$)																																			
Total Operating Costs																																			
CAPITAL COST - PREPRODUCTION																																			
A Mine Development																																			
C Mine																																			
E Concentrator																																			
C Mine Infrastructure																																			
C Pipeline																																			
C Slaus Lookout Infrastructure																																			
C Rail																																			
E Pellet Plant																																			
E HBI Plant																																			
Total Direct & Indirect Capital Costs																																			
CAPITAL COST - SUSTAINING																																			
D Open Pit Mine																																			
F Process Mine Site																																			
D Tailings and Waste Management																																			
D Concentrate Pipeline and reclaim water																																			
D Power and Communication Mine Site																																			
D Main Road to Mine Site																																			
D Camp Mine Site																																			
D Infrastructure Mine Site																																			
D Casework and Dyers																																			
F Process Area Slaus-Lookout Site																																			
D Power and Com. Slaus-Lookout Site																																			
D Railroad Facilities at Slaus-Lookout Site																																			
D Infrastructures Slaus-Lookout Site																																			
Total Sustaining Capital Costs																																			
SALVAGE VALUE (\$)																																			
WORKING CAPITAL (\$)																																			
Cumulative Working Capital																																			
NET FINANCING																																			
Payments to / (From) Lenders																																			
Total Tax Payments																																			
Federal Corporate Taxes																																			
Provincial Corporate Taxes																																			
Mining Taxes																																			
B-T CASH FLOW																																			
Cumulative																																			
Payback Period work area																																			
A-T CASH FLOW																																			
Cumulative																																			
Payback Period work area																																			
Return-Tax																																			
Payback Period																																			
Net Present Value @ 6.0%																																			
Net Present Value @ 8.0%																																			
Net Present Value @ 10.0%																																			
Internal Rate of Return																																			
After-Tax																																			
Payback Period																																			
Net Present Value @ 6.0%																																			
Net Present Value @ 8.0%																																			
Net Present Value @ 10.0%																																			
Internal Rate of Return																																			

Figure 22-2 - Pre-tax NPV8%: Sensitivity to Pre-production Capital Cost, Operating Cost and Price

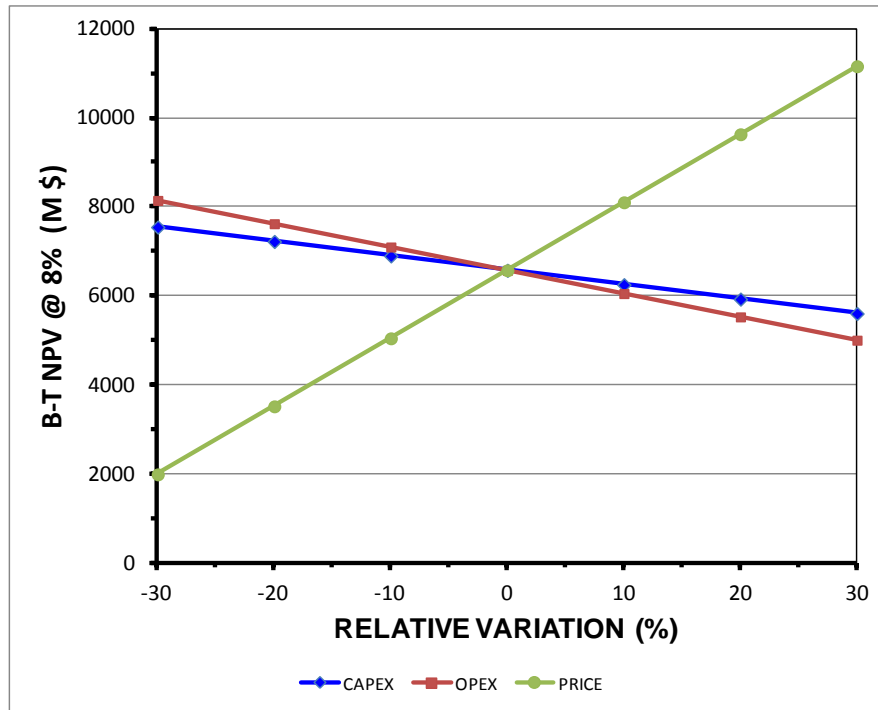
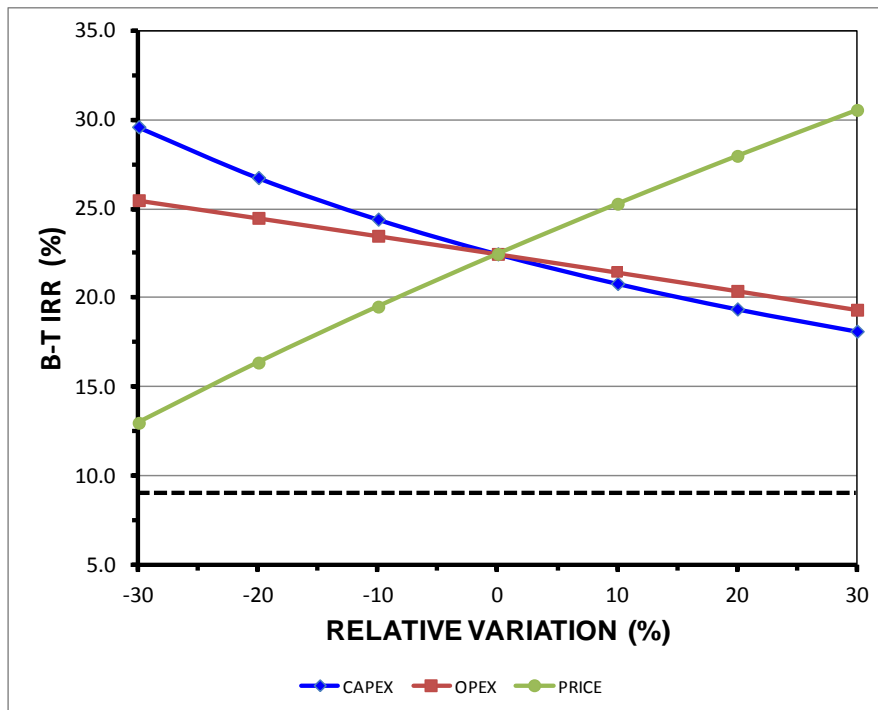


Figure 22-3 - Pre-tax IRR: Sensitivity to Pre-production Capital Cost, Operating Cost and Price



CIMA+ M03802A



Figure 22-4 - Post-tax NPV_{8%}: Sensitivity to Pre-production Capital Cost, Operating Cost and Price

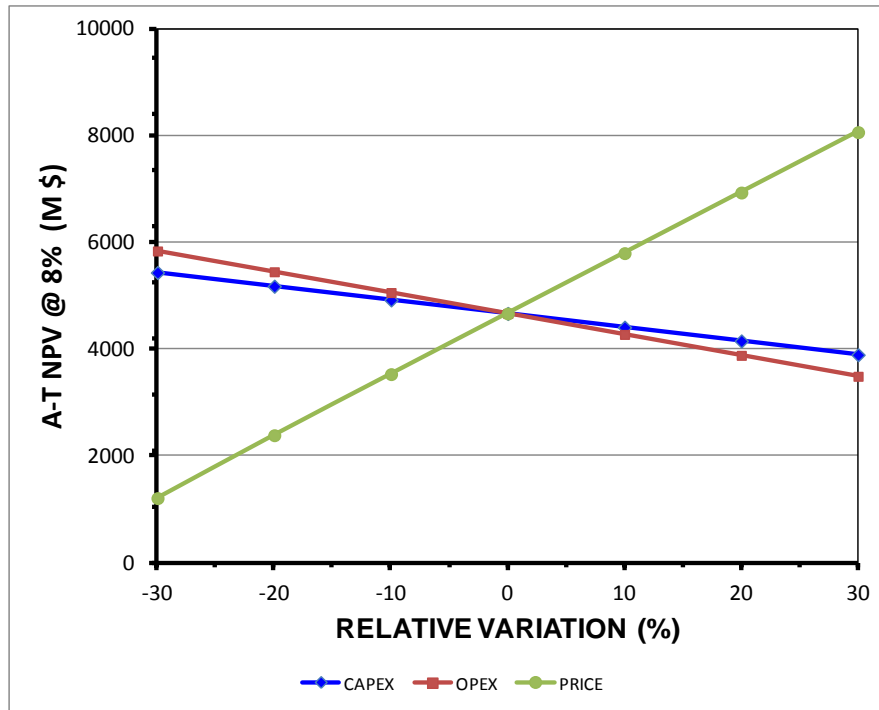
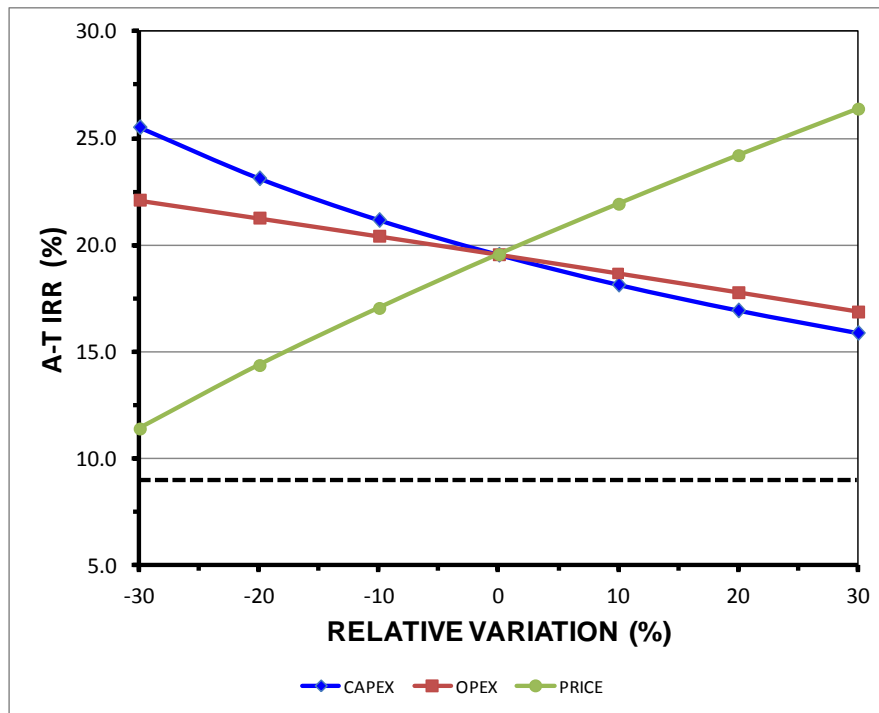


Figure 22-5 - Post-tax IRR: Sensitivity to Pre-production Capital Cost, Operating Cost and Price



CIMA+ M03802A



22.6 Important Caution Regarding the Economic Analysis

The economic analysis contained in this report is preliminary in nature. It incorporates inferred mineral resources that are considered too geologically speculative to have economic considerations applied to them that would enable them to be categorized as mineral reserves. This should not be considered a prefeasibility or feasibility study. There can be no certainty that the estimates contained in this report will be realized. In addition, mineral resources that are not mineral reserves do not have demonstrated economic viability.

23 Adjacent Properties

No claims held by other parties are contiguous to the Property and no current exploration activities for iron deposits are taking place in the immediate vicinity of the Property. However, Rockex holds a 100% interest in two (2) other iron projects in relative close proximity to the Property:

- The East Soules Bay property consisting 4 contiguous mining claims and 1 non-contiguous mining claim, in and along the eastern end of Lake St. Joseph, approximately 40 kilometres east of Rockex' Eagle Island Iron Project;
- The Root Lake Project, a property consisting of 5 contiguous claim.

Another iron property held by Sanjo Iron Mines Limited, a wholly-owned subsidiary of Steep Rock Iron Mines Limited, is located on the SW of the East Soules Bay property. The property covers part of the interpreted extension of the iron formation within the East Soules Bay claims. Between 1956 and 1961, the Sanjo property was tested by airborne and ground magnetometer surveys, by 8,622.8 m (28,290 ft) of diamond drilling, by shaft-sinking and crosscutting, bulk sampling (250 long tons) and metallurgical test work. The North Zone was explored over a strike length of about four (4) km and to a depth of about 200 m by 26 drill holes. The South Zones has been traced over a reported length of about 4.5 km, to a depth of 170 m, by 13 drill holes. This work culminated with a resource estimate.

No recent activity has been reported on these iron properties, except for an airborne magnetic survey over the Doran Lake area by Rockex in 2011.

The reader is advised that the information provided in this Section was publicly disclosed and is mostly drawn from assessment files, or maps and reports from the Ontario Department of Mines, derived from an Internet search. The qualified person has not attempted to verify the data and results and the presence of iron formation in adjacent properties is not necessarily indicative of the mineralization on the Property that is subject of the present Technical Report.

24 Other Relevant Data and Information

No other relevant data and information is available for the Lake St. Joseph property.

CIMA+ M03802A



25 Interpretation and Conclusions

25.1 Mineral Resources

The exploration and drilling data available for the portion of the iron formation located on Eagle Island are sufficiently complete and adequate to support the estimation of the Mineral Resources estimate that served as the basis of the present PEA.

25.2 Mining Method

The pit design and mine plan were limited to a 30-year mine life for the PEA, even though there are sufficient Mineral Resources for a longer period. The 30-year pit that has been designed for the Eagle Island deposit is approximately 2,000 m long and 900 m wide at surface with a maximum pit depth of 400 m.

The pit includes 512 Mt of Mineral Resources with an average Fe grade of 28.9% and has a strip ratio of 0.51:1 with 26 Mt of overburden and 233 Mt of waste rock. Only 1.4% of the Mineral Resources contained within the pit are in the Inferred category.

The pit will be developed in three (3) phases in order to delay the dyke construction and lake dewatering. In phase 1, (years 1 to 2) the mine can be operated without the need for dyking. Phase 2 (years 3 to 8) requires a short temporary dyke and Phase 3 (years 9 to 30) requires the final dyke.

A production schedule (mine plan) was developed to produce 6 Mt of pellet feed per year. Using the mill recovery of 80% and a targeted pellet feed grade of 66.3% results in an average run of mine feed of 17.3 Mt per year at an average Fe grade of 28.9%.

25.3 Processing and Metallurgy

The most important conclusions from the metallurgical test program performed for the purposes of the project include:

- The tested mineralization was amenable to gravity separation techniques. A concentrate with a weight recovery of 14.5% and 67.5% Fe can be produced while a tail corresponding to 26.6% weight can be rejected with a loss of 12.6% Fe;
- The magnetite within the tested material was concentrated via low intensity magnetic separation. A weight recovery of 20.8% was achieved with a corresponding Fe grade of 66.9%;

- Desliming results achieved were comparable to those obtained by Algoma, with recoveries ranging between 80 to 70% and Fe grades ranging between 65 to 67%;
- The required concentrate grade parameters of Fe above 65% and SiO₂ near 5% from the Western Lake St. Joseph Project mineralization can be achieved;
- Potentially, the weight recovery can be increased by using wet high intensity magnetic separation and or with hydraulic separation.
- The final concentrate produced by the concentrator is fine enough to be used directly by a pellet plant without further grinding and can be classified a “pellet feed”.

The developed based on the test program flow sheet uses conventional, proven, grinding, gravity, magnetic and decantation equipment to produce six (6) Mt per year of hematite/magnetite pellet feed (as with the feed, proportions of the minerals are a 50:50 ratio) grading at 66.3% Fe and 5.23% silica with a recovery of 80% of the Fe value and a weight recovery of 34.6%. This is then transported to a Pellet plant to produce six (6) Mt per year of hematite/magnetite pellets, which are fed to a HBI plant to produce a final product of 4.3 Mt per year of hematite/magnetite HBI at an expected metalization of 94% Fe.

25.4 Infrastructure

The open pit, waste and overburden dumps are located on the Eagle Island. The concentrator, accommodation camp, offices and workshops, are located on the south shore of the Lake St. Joseph. Drainage ditches will be constructed around the open pit and dumps to direct water runoff to settling ponds to avoid contamination. The mineralized material will be hauled by the mine haul trucks to the gyratory crusher via the causeway that will linked the island and the south shore. A haulage road will be constructed between the mine and the crushers. The mine facilities will produced annually 6 Mtpa of iron concentrate. The concentrate will be conveyed into a slurry by the concentrate pipeline to Sioux Lookout.

At Sioux Lookout, the concentrate will be dewatered, pelletized, and briquetted to be shipped by rail. The pellet plant, the hot briquetted iron plant, offices, workshop, gas separation plant and train load-out are on the same processing complex east of Sioux-Lookout.

The CN Rail mainline network traverses the town of Sioux-Lookout. The CP Rail network is located 70 km south of Sioux-Lookout, providing an opportunity to conduct future trade off studies to determine which network will service the project.

25.5 Environmental and Social Aspects

The Project will be subject to Environmental Assessment in accordance with provincial and federal requirements. Following release from the provincial and federal EA processes, the project will require a number of approvals, permits and authorizations prior to initiation and throughout all stages in the life of the project. In addition, Rockex will be required to comply with any other terms and conditions associated with the EA release issued by the provincial and federal regulators.

25.6 Economic Analysis

An economic/financial analysis has been carried out for the Lake St. Joseph Project (Eagle Island deposit) using an annual concentrate production rate of 6 Mt further processed into 4.3 Mt of hot briquetted iron (HBI) at an expected metalization of 94% Fe. The project's life is limited to 30 years of production.

A cash flow model is constructed on an annual basis in constant money terms (second quarter 2015). No provision is made for the effects of inflation. The Project is assessed on a "100%-equity" basis (i.e. unlevered cash flows) in conjunction with a discount rate that represents the cost of equity capital.

A long-term FOB Sioux Lookout price of 350 USD/t of product is assumed, the location from which it is to be sold to potential customers. A long-term exchange rate of 0.85 USD/CAD is assumed over the life of the Project.

The summary of the economic analysis is shown in Table 25-1.

Table 25-1 – Summary of Financial Results

Description	Units	Value
Total FOB Revenue	M\$	52,682.6
Total Operating Costs (including royalty)	M\$	18,376.4
Total Pre-Production Capital Costs (excluding Working Capital)	M\$	3,772.0
Total Sustaining Capital Costs	M\$	538.3
Total Closure Costs	M\$	65.7
Salvage Value	M\$	187.8
PRE-TAX		
Total Cash Flow	M\$	30,118.0
Payback Period	Years	3.7
Net Present Value @ 8%	M\$	6,577.5
Net Present Value @ 6%	M\$	9,421.1
Net Present Value @ 10%	M\$	4,603.8
Internal Rate of Return	%	22.5
POST-TAX		
Total Cash Flow	M\$	22,624.0
Payback Period	years	4.1
Net Present Value @ 8%	M\$	4,672.6
Net Present Value @ 6%	M\$	6,850.0
Net Present Value @ 10%	M\$	3,158.2
Internal Rate of Return	%	19.5

The economic analysis contained in this report is preliminary in nature. It incorporates inferred mineral resources that are considered too geologically speculative to have the economic considerations applied to them that would enable them to be categorized as mineral reserves. It should not be considered a prefeasibility or feasibility study. There can be no certainty that the estimates contained in this report will be realized. In addition mineral resources that are not mineral reserves do not have demonstrated economic viability.

25.7 Risks

There are some risks inherent to a mining project such as:

- Environmental Impact Assessment timing;
- Discussions with the different communities;
- Geotechnical Assessment;

Other, generally more important risks that could delay the construction and production of the project are:

- The assumption, there is available land to build the pellet and a hot briquetted iron plant beside the railroad at Sioux-Lookout;
- The assumption that the electric power line and thus electric power is available on time for the construction for the project and subsequent concentrate production.
- The assumption that the natural gas pipeline is available on time for the construction for the project and subsequent concentrate production.
- And naturally the most important risk is the price of hot briquetted iron which will materially impact project start-up.

25.8 Conclusion

With the estimated Capital Cost of (M\$3,772) and an average Operating Cost of \$135.35/ tonne of HBI, the Economic Analysis shows, at a selling price of US\$350/t of HBI FOB Sioux-Lookout, an IRR of 22.5% (Before Tax) and IRR of 19.5% (After Tax).

26 Recommendations

26.1 Mining and Geology

- A more detailed survey should be carried out to determine the topographic elevations on Eagle Island, the thickness of overburden and the elevation of the lake bottom.
- Geotechnical and hydrogeological studies should be performed to further confirm rock slopes, rock permeability, ground and underground water flows in order to validate the open pit mining technical parameters.
- The maximum lake elevation should be reconfirmed with Ontario Hydro since the current letter dates from 1969.
- An in-depth geotechnical study should be carried out to validate the dyke design parameters.

26.2 Metallurgy and Process

In general the work to further improve the process parameters and optimise the flowsheet should concentrate on the following:

- To improve the iron recovery while maintaining the iron content above 65% and SiO_2 below 5%, the test work studies as in Section 13.5 below have to be optimised and reproduced in a variability study;
- Desliming test work needs to investigate to benefit of more recent reagents. Although the reagents used were effective, recent advances in desliming reagents may provide chemicals that provide superior results.
- The flow sheet has to be confirmed with both lock-cycle and pilot plant testing.

In order to attain the next level of study, the following test works are recommended.

26.2.1 Further Mineralogical Examination

Additional and more detailed mineralogical examination by X-ray powder diffraction, optical microscopy, micro-probe and Quantitative Evaluation of Minerals by Scanning electron microscopy (QEMSCAN™) to be performed on new representative samples to confirm the material properties of the ore.

26.2.2 Lock-Cycle Test Work

The various stages of the process need to be tested in combination to determine how the processes combine together. A lock-cycle is required to determine overall process recovery and concentrate grade.

26.2.3 Pilot Plant Test Work

The pilot plant data will give significant amounts of additional data. Since this mineralization type is complex in nature, this step is of major importance to validate the adopted flow sheet.

26.2.4 Comminution Test Work

To improve the accuracy of the SAG mill sizing in the pre-feasibility phase, crushing and grinding test work is recommended to evaluate the variability of the mineralization. Existing drill core samples should be used for this purpose. A JK Drop Weight Test should be performed on a representative composite of the mineralization as it will be mined while SMC Tests should be performed on the lithologies present to gauge the variability of the deposit.

26.2.5 Concentrate Slurry Transport Test Work

As this section will be a major expense, for the pre-feasibility study, slurry transport testing should be performed. Due to the fine nature of the pellet feed, rheology testing is needed especially with a focus on the effect due to changes in pulp density.

26.2.6 Concentrate and Pellet Feed Settling Test Work

For the pre-feasibility study, settling testing for thickeners should be done. This can be done using a testing laboratory or a vendor facility.

26.2.7 Pellet Feed Filtration Test Work

For the pre-feasibility study, testing for filtration equipment should be done.

26.2.8 Balling Design Parameter Test Work

Balling test work is suggested, but not required for pre-feasibility. The balling design parameters should comprise:

- Green pellet chemical analysis (including but not limited to the content of water, magnetite, hematite, elemental iron, dolomite, limestone, hydrated lime, blast furnace slag or scale and recycle fired pellets);
- Green pellet physical analysis (including green pellet size distribution, crushing strength, tumbler strength, porosity, specific gravity and bulk density).

26.2.9 Pot Grate Design Parameter Test Work

Pot Grate testing is suggested, but not required for pre-feasibility. To provide prospective customers with a proven quality product, balling and pot grate test work should be done.

The pot grate design parameters test work should be based on fired pellets and include:

- Pre-heating (drying) time, temperature, air flow and heat requirements;
- Induration (cooking) time, temperature, air flow and heat requirements;
- Cooling time, temperature, air flow and heat requirements;
- Optimal hearth layer thickness for the above;
- Fired pellet physical analysis (including fired pellet size distribution, crushing strength, tumbler strength, porosity, specific gravity and bulk density);
- Fired pellet chemical analysis (including assay results of fired pellet and analytical results of the minerals and mineralogical structure);
- Fired pellet metallurgical test work results (including reducibility, swelling reduction and softening).

26.2.10 Wet High Intensity Magnetic Separation (“WHIMS”)

Testing of the tails from the LIMS circuit with a high intensity type of separation equipment should be further investigated. Due to the fine nature of the material at its liberation size, a SLON is the suggested device.

26.2.11 Hydraulic Separation Test Work

Testing of the material with a hydraulic classifier at coarser size range and a reflux classifier at the finer size range may provide similar/better results than the desliming circuit.

26.3 Environmental and Social Aspects

- Meetings and consultation with stakeholders should continue as the Project advances to pre-feasibility study;
- Baseline field work should be initiated;
- Testing for acid rock drainage and metal leaching should be conducted on mine rock and tailings samples.

26.4 Infrastructures

With respect to infrastructure, CIMA+ recommends to:

- To initiate discussion with power electric company to confirm power availability;
- To initiate discussion with natural gas pipeline company to confirm gas availability;
- To initiate discussion with existing railroad operators;
- To initiate discussion with for a land at Sioux-Lookout.

26.5 Recommended Work Program and Estimated Costs

Table 26-1 shows the recommended work program and estimated costs.

Table 26-1 – Recommended Work Program

Description	Cost
Pre-Feasibility Study	\$1,500,000
Environmental Baseline and Studies	\$1,600,000
Metallurgical Testwork	\$ 1,000,000
Total	\$4,100,000



27 References

- [1] Met-Chem Canada Inc., 2013: NI 43-101 Technical Report on the Preliminary Economic Assessment on Lake St. Joseph Iron Property Ontario – Canada. Prepared by Y.A. Buro, S. Ibrango, J. Cassoff, R. Cunningham, A. Michaud, M.-J. Buchanan, M.L. Bilodeau, C. Calota, C. Cauchon for Rockex Mining Corporation. National Instrument 43-101 report dated October 11, 2013, available on SEDAR.